

# ITER Physics and Technology

Exploring Magnetically-Confined  
Burning Plasmas  
in the Laboratory  
with  
Early Integration of  
Physics and Technology

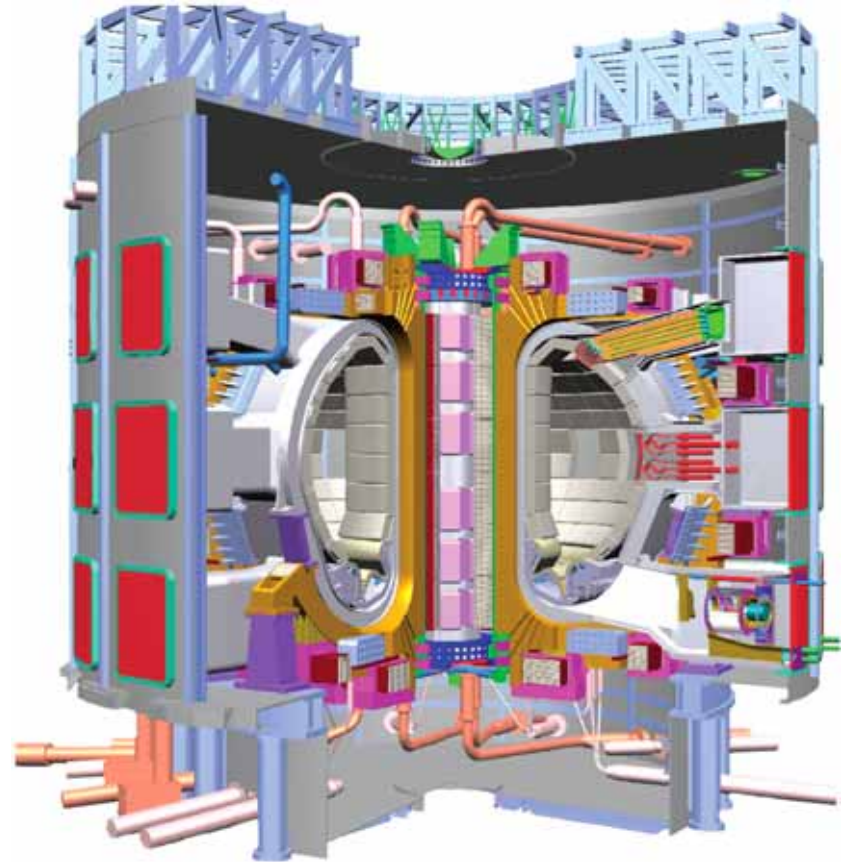

**Ned Sauthoff**  
**April 4, 2005**

# Deuterium-Tritium Fusion Reaction

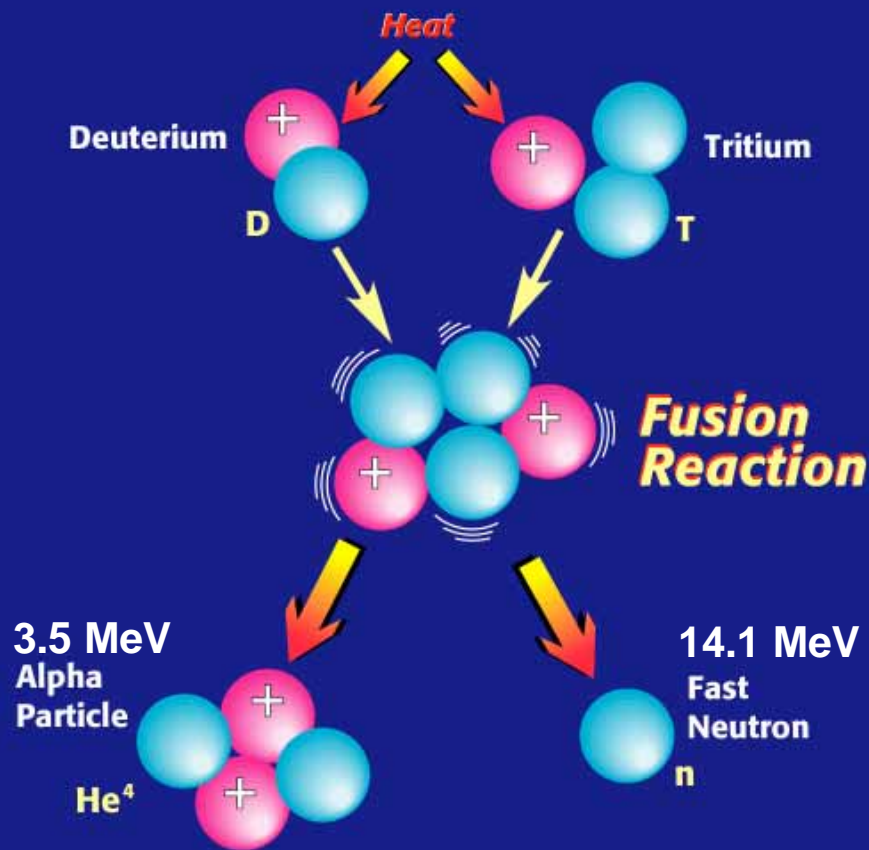

## Key Science Topics of Burning Plasmas:

- Self-heating and self-organization
- Energetic Particles
- Size-scaling

Plasma self-heating



# The Tokamak is Ready for a Burning Plasma Test

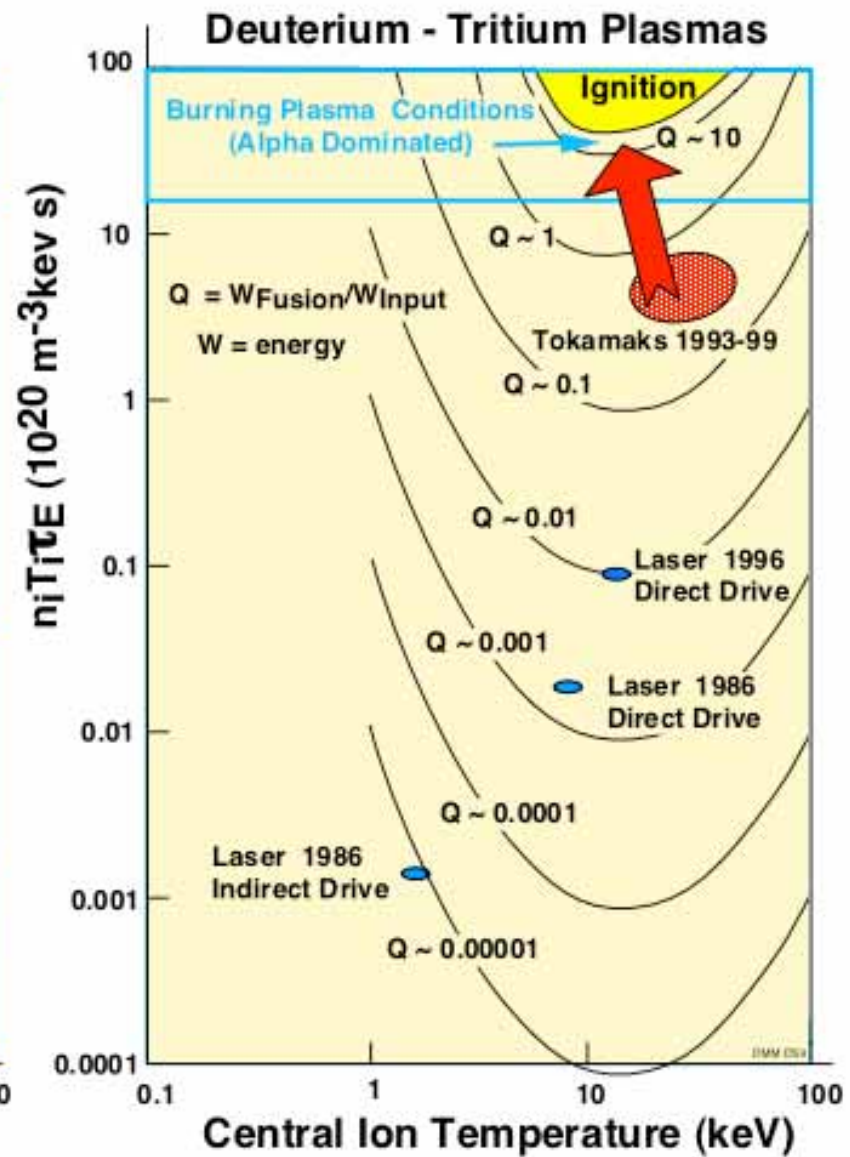
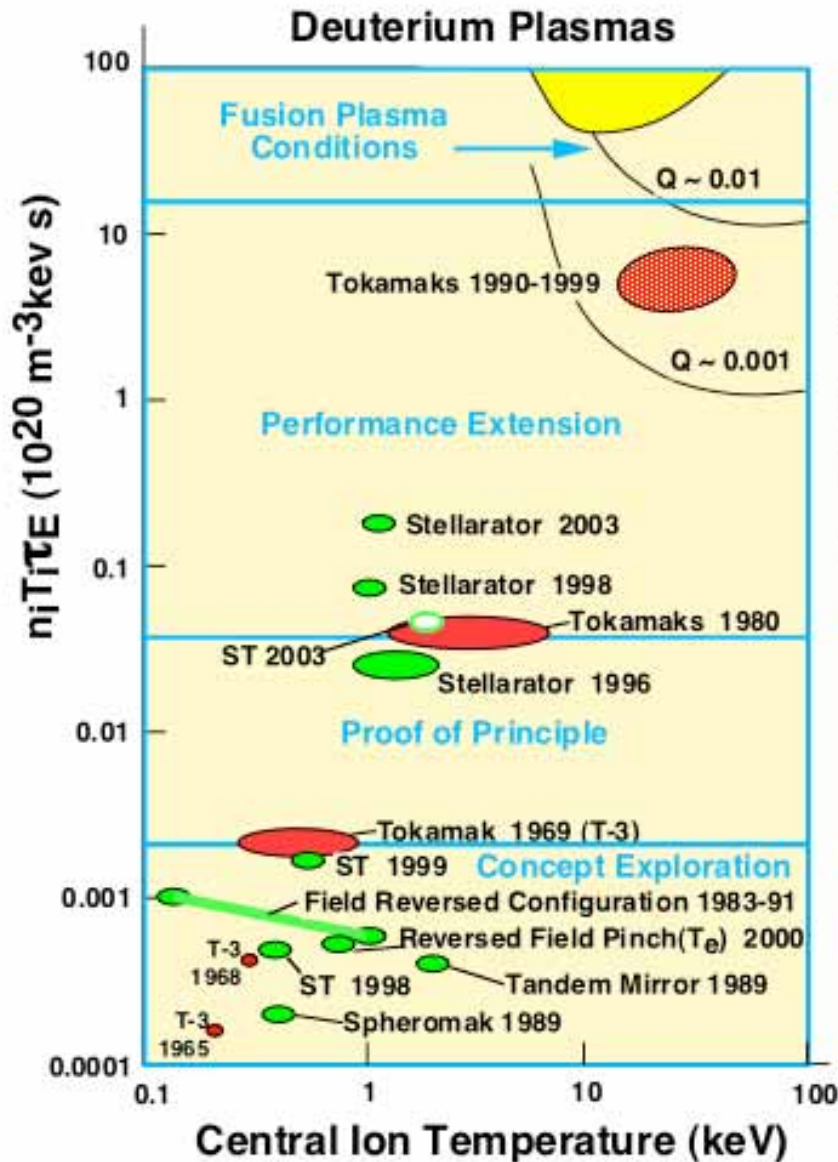

# International Thermonuclear Experimental Reactor (ITER)

## *ITER's Mission:*

*To Demonstrate the  
Scientific and Technological  
Feasibility of  
Fusion Energy  
for Peaceful Purposes*

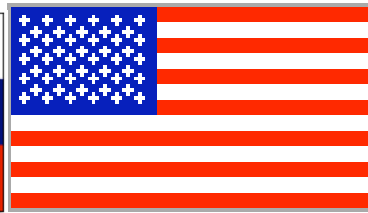
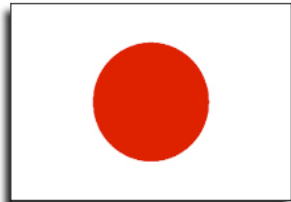
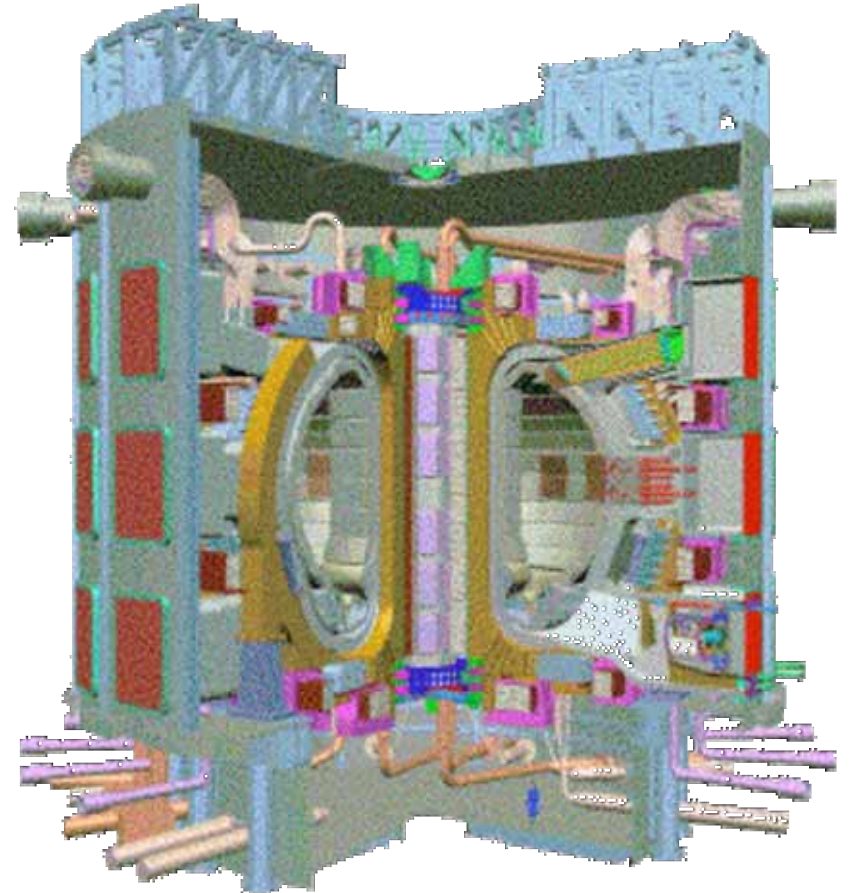

## Special ITER Features for Burning Plasmas and Steady-State Studies

- ITER has the most comprehensive scope: integration of burning plasma physics and technology
- Operating space “large and robust” [Snowmass]
- “Most complete set of tools” for study of transport [Snowmass]
- 25 keV temperatures enable studies of reactor-like energetic particle modes ( $\beta_\alpha$  and  $\beta$  for positive- and reverse-shear scenarios, avalanches, ...)
- Proven plasma-control tools (Electron Cyclotron for localized Current Drive; Neutral Beams for heating and diagnostics)
- Pulse length from 400 seconds (inductive,  $2.6\tau_R$ ) to 1000 seconds (hybrid,  $6\tau_R$ ) to 3000 seconds (steady-state,  $20\tau_R$ )
- Actively cooled plasma-facing surfaces and nuclear shielding
- Integrated operation of reactor technologies

## Plasma control tools

Topic	IC (20MW @ 40- 55MHz)	EC (20MW @ 170 GHz)	LH (20 MW @ 5GHz)	NB (33- 50MW @ 1MeV)	Magnets
Pressure Profile	P(0), possibly P(R)	P(R)	$r > a/2$	P(0)	
Current Density Profile	J(0), possibly J(R)	J (R)	$J_{\text{efficient}} (r > a/2)$	J(0)	
Shaping					$\kappa_x \sim 1.9, \kappa_{95\%} \sim 1.7$ $\delta_x \sim 0.5, \delta_{95\%} \sim 0.33$
RWM Stab.					Port-based coils?
NTM Stab.		localized			
Flow/rotation	???			weak	
Energetic Particles	TAE			TAE ?	

# Transport

- **Opportunities:**
  - reactor-scale ( $\rho_*$ ,  $v_*$ ,  $\beta$ ,  $n/n_G$ )
  - nonlinear couplings (  $\alpha$ , flows, equilibrium, MHD stability)
  - pedestal characteristics
  - core-edge integration
  - ITB-access at low- $\rho_*$  with weak rotation
- **Demands:**
  - flexible configuration
  - control tools
  - profile diagnostics
  - turbulence diagnostics

# MHD

- **Opportunity: low- $v_*$ , low- $\rho_*$ , isotopic- $\alpha$ 's, self-heated/self-organized, low rotation**
- **MHD is not a fundamental obstacle for baseline scenarios**
- **Sawteeth not expected to be a barrier, but could trigger NTMs**
- **For advanced scenarios:**
  - active control of NTMs
  - active control of RWMs (rotation + feedback coils)



# High-Level Physics R&D for ITER

- **Addressing near-term design issues**
  - Disruption characteristics in a range of scenarios
  - Heat loads and mitigation
  - Diagnostics for long-pulse burning plasmas
    - techniques for real-time erosion, dust generation/transport, confined alphas
    - environmental issues (radiation, erosion, deposition)
  - Integrated modeling
- **Addressing ITER Research Operations, focusing on steady-state high-performance**
  - current drive requirements for profiles and NTM stabilization
  - high density operation
  - high radiation-fraction operation
  - $\beta$ -limits and control of MHD instabilities

# Early U.S. ITER Activities (1988-1998)



- 1988-90** • Europe, Japan, USSR and US conducted Conceptual Design Activity (CDA)

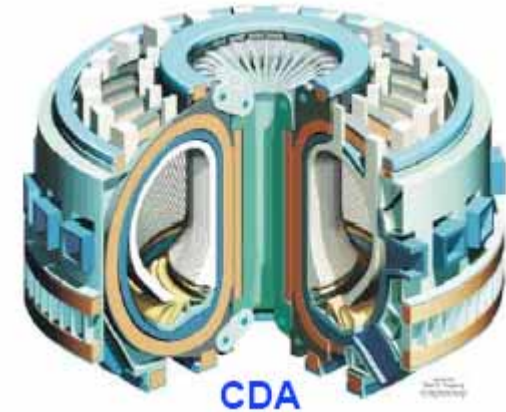

- 1992** • Engineering Design Activity (EDA) started with 3 co-centers (EU, Japan, US)



- 1998** • Initial EDA period ends with final design report
- US urged rescoping to reduce cost

# Re-scoping by Special Working Group 2 (1998)

- **Plasma Performance**

- The device should:
  - **achieve extended burn in inductively driven plasmas with the ratio of fusion power to auxiliary heating power of at least 10** for a range of operating scenarios and with a duration sufficient to achieve stationary conditions on the time scales characteristic of plasma processes.
  - **aim at demonstrating steady-state operation** using non-inductive current drive with the ratio of fusion power to input power for current drive of **at least 5**.
- In addition, the possibility of controlled ignition should not be precluded.

- **Engineering Performance and Testing**

- The device should:
  - **demonstrate the availability and integration of technologies essential for a fusion reactor** (such as superconducting magnets and remote maintenance);
  - **test components for a future reactor** (such as systems to exhaust power and particles from the plasma)
  - **test tritium breeding module concepts** that would lead in a future reactor to tritium self-sufficiency, the extraction of high grade heat, and electricity production.

# Intermediate U.S. ITER Activities (1998-2001)

---

- 1998** • US withdraws from ITER at Congressional direction; EDA Extension starts with EU, JA and RF pursuing lower-cost, more advanced design including systematic studies of a range of aspect ratios
- 2001** • EDA ends with de-scoped design

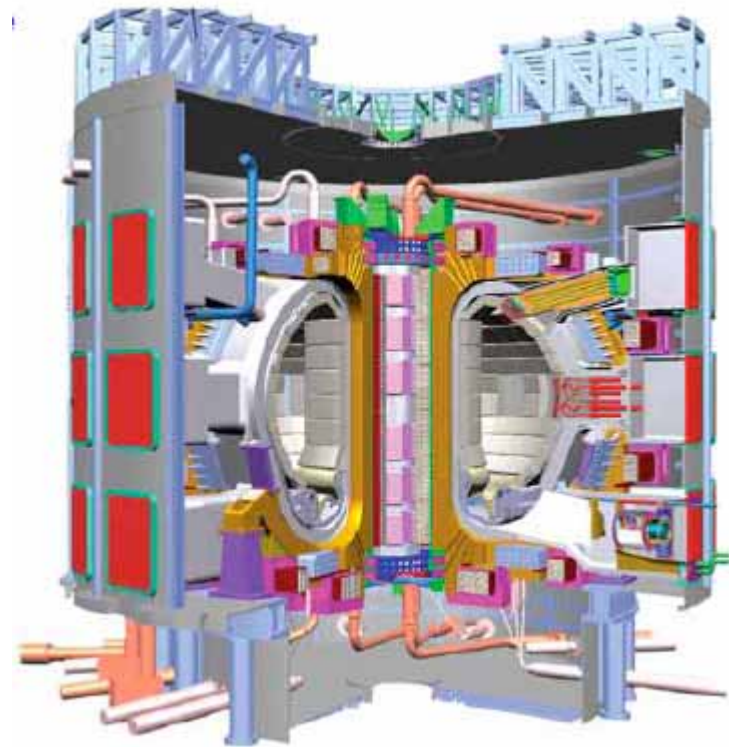

EDA 2001

# Evolution of the ITER design

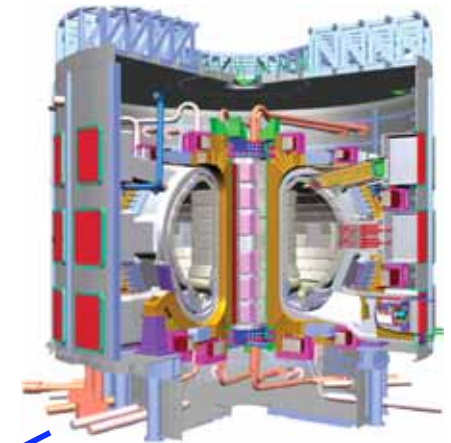
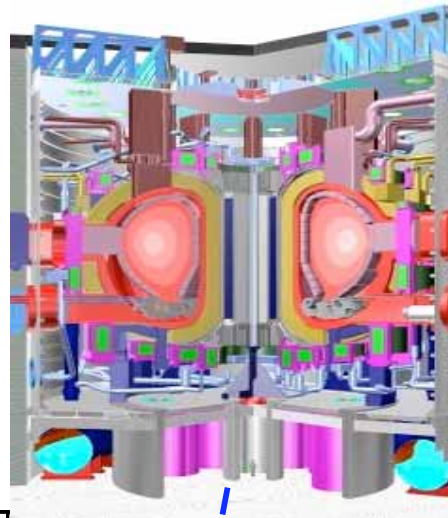
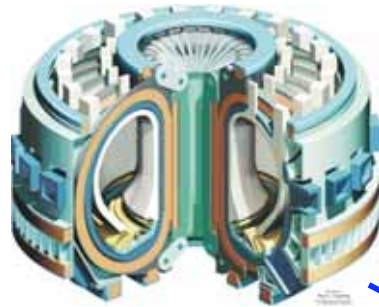

	CDA 1990	EDA 1998	EDA 2001
Plasma major radius (m)	6.0	8.1	6.2
Plasma half width at mid-plane (m)	2.1	2.8	2.0
Toroidal magnetic field on axis (T)	4.85	5.6	5.3
Nominal maximum plasma current (MA)	22	21	15
Nominal fusion power (MW)	1000	1500	500
$Q (=P_{\text{fusion}}/P_{\text{heating}})$ (reference plasma)		infinity	$\geq 10$
$Q (=P_{\text{fusion}}/P_{\text{heating}})$ (steady-state)		$\geq 5$	$\geq 5$
Nominal inductive pulse length (s)	$>200$	$>1000$	$>400$
Average neutron wall load ( $\text{MW}/\text{m}^2$ )	$\sim 1.0$	$\sim 1.0$	0.57
Neutron fluence ( $\text{MW years}/\text{m}^2$ )		1.0	$\geq 0.3$

# ITER integrates science and long-pulse technology for the study of sustained burning plasmas

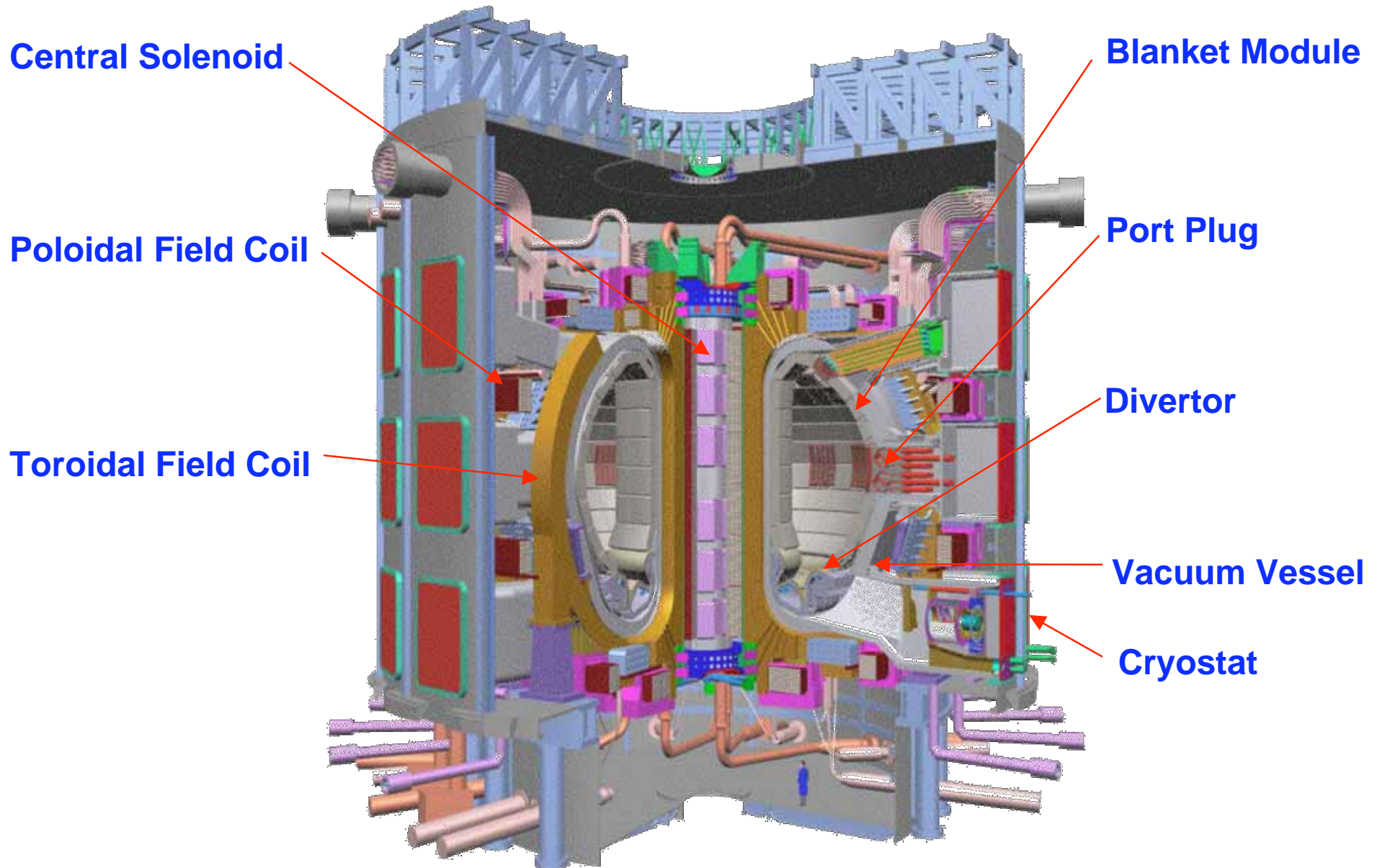

# ITER Technology was developed between 1992 and 1998

## CENTRAL SOLENOID MODEL COIL

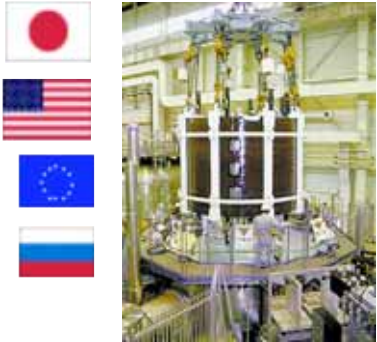

Radius 3.5 m  
Height 2.8m  
 $B_{max}=13$  T  
 $W = 640$  MJ  
0.6 T/sec



R&D Activities completed by July 2001.

## VACUUM VESSEL SECTOR



Double-Wall, Tolerance  $\pm 5$  mm



## BLANKET MODULE



HIP Joining Tech  
Size : 1.6 m x 0.93 m x 0.35 m



## REMOTE MAINTENANCE OF DIVERTOR CASSETTE



Attachment Tolerance  $\pm 2$  mm



## TOROIDAL FIELD MODEL COIL



Height 4 m  
Width 3 m  
 $B_{max}=7.8$  T  
 $I_{max} = 80$  kA



## REMOTE MAINTENANCE OF BLANKET



4 t Blanket Sector  
Attachment Tolerance  $\pm 0.25$  mm



## DIVERTOR CASSETTE



## **Recent U.S. ITER Activities (2001 – 2002)**

---

- 2001**
  - **ITER Coordinated Technical Activities / Transitional Arrangements started with EU, JA, RF, and CA**
  - **Intent was short duration, transition to ITER construction.**
    - **Select site – CA, EU, and JA offers made.**
    - **Negotiate Agreement**
    - **Complete Design**
- 2002**
  - **Joint Assessment of Sites carried out by Parties**
  - **US Snowmass Fusion Summer Study**
  - **Lehman Review of ITER (Value) Cost Estimate (11/02)**



# Snowmass Assessment of contributions of the options

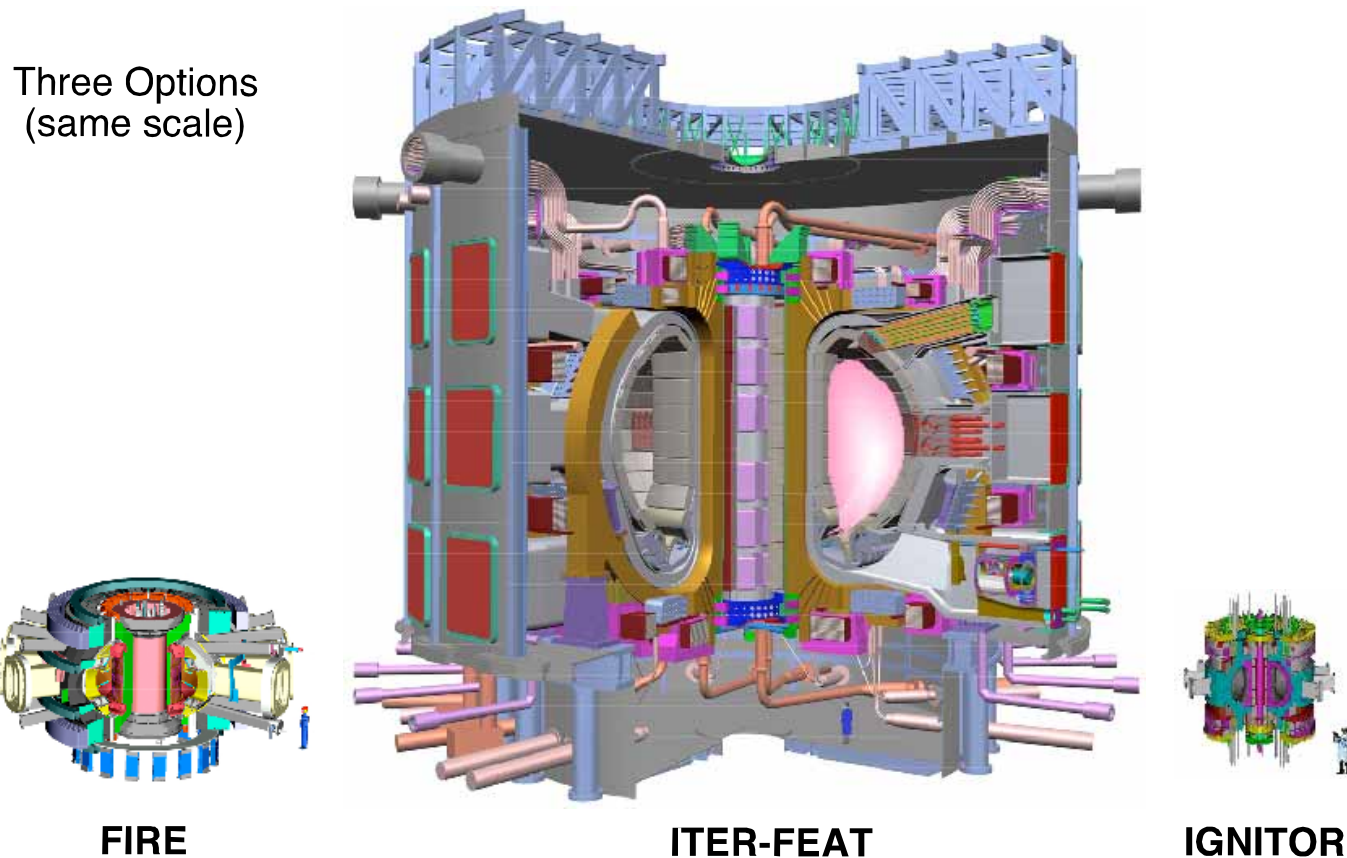

- **IGNITOR, FIRE, and ITER would enable studies of the physics of burning plasma, advance fusion technology, and contribute to the development of fusion energy.**
- **The contributions of the three approaches would differ considerably.**

## NRC: “Burning Plasma: Bringing a Star to Earth”

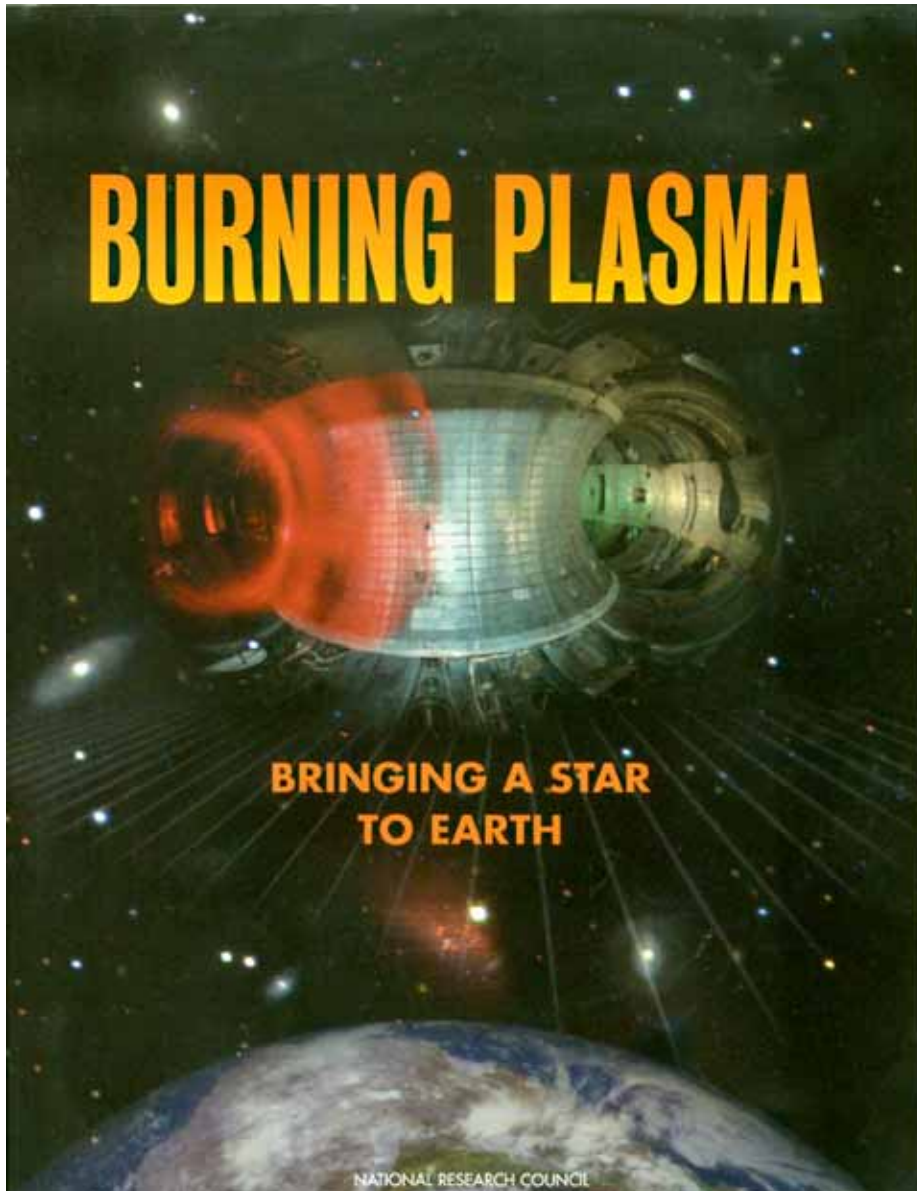

- “The United States should participate in ITER. If an international agreement to build ITER is reached, fulfilling the U.S. commitment should be the top priority in a balanced fusion science program.”
- “The United States should pursue an appropriate level of involvement in ITER, which at a minimum would guarantee access to all data from ITER, the right to propose and carry out experiments, and a role in producing the high-technology components of the facility consistent with the size of the U.S. contribution to the program.”

# National Academy of Science

---

---

- **The National Research Council (NRC) reviewed the U.S. burning plasma strategy from an independent perspective of the larger U.S. science community. In December 2002...**
  - endorsed the need for sustained burning plasma research
  - recommended that the U.S. should pursue an appropriate level of involvement in ITER.
- **NRC clearly recommended exclusive focus on the ITER option while ITER negotiations are underway, with pursuit of alternatives only if acceptable ITER arrangements cannot be achieved.**

## US decision on joining ITER Negotiations (1/30/03 )



“Now is the time to expand our scope and embrace international efforts to realize the promise of fusion energy.

Now it is time to take the next step on the way to having fusion deliver electricity to the grid.

The President has decided to take that step.

Therefore, I am pleased to announce today, that President Bush has decided that the United States will join the international negotiations on ITER.”

(Energy Secretary Abraham at PPPL)

## **Recent U.S. ITER Activities (2003)**

---

- 2003 • U.S., Korea, and China joined negotiations**
- U.S. negotiating limits established – 6/03**
- Intense working level discussions  
(Garching, Tokyo, Abingdon, Beijing)**
- Agreement was advanced; some difficult issues remain**
- Ministerial Meeting (12/03) ends with site stalemate**
- ITA is over-extended, resources inadequate for ITER Team, resulting in faltering transition.**

# Site Selection Sequence/Schedule



**France  
(Cadarache)**



**Spain  
(Vandellòs)**

**Nov 26, 2003**



**EU site  
(Cadarache)**



**Japan  
(Rokkasho)**



**withdrew**

**Canada  
(Clarington)**

## **Recent U.S. ITER Activities (2004 - 2005)**

---

- 2004**
  - **Technical comparisons of candidate sites**
  - **Explorations of broader approaches**
  - **High-level site negotiations in Vienna**
  - **U.S. announces U.S. ITER Project Office in July 2004**
  - **EU/JA bilateral site negotiations begin**
  
- 2005**
  - **U.S. Contributions to ITER in FY06 Budget with Total Project Cost of \$1.122B**
  - **EU and JA negotiating**

# Status of Negotiations on ITER Site

- Six parties asked Host candidates to find solution to site issue
- EU and JA exchanged serious proposals and continue high-level bilateral talks
  - EU proposes starting political discussions
  - JA proposes continuing technical discussions
  - Leaders of France and Japan met in March; bilaterals now
- No six-party meeting scheduled yet





## **Provisional allocation of ITER scope**

- **In 2000, the EU, JA and RF estimated the fabrication costs of the ITER components based on procurement packages.**
- **In 2003, the Negotiators approved the 2003 ITER values of the packages as an appropriate basis for the allocation of scopes**
- **In July-September 2003, technical representatives of the parties developed provisional allocations of packages (totaling 85% of the value), which the Negotiators agreed were appropriate for future planning**
- **Scopes and roles need to be finalized after the ITER Agreement and subsequent formation and action of the ITER team**

# U.S. provisional “in-kind contribution” scope

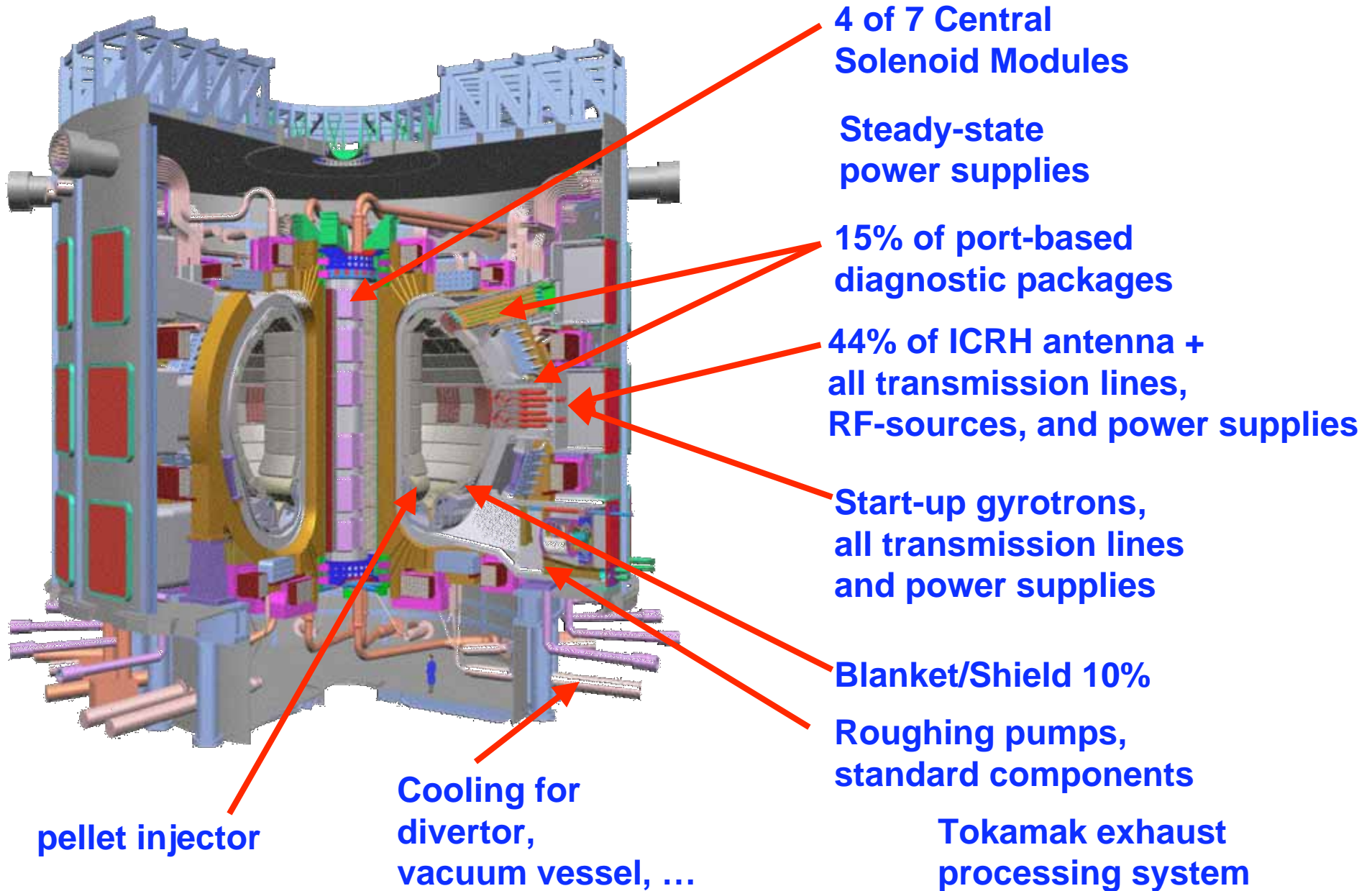

## Alternative U.S. “in-kind contribution” scope

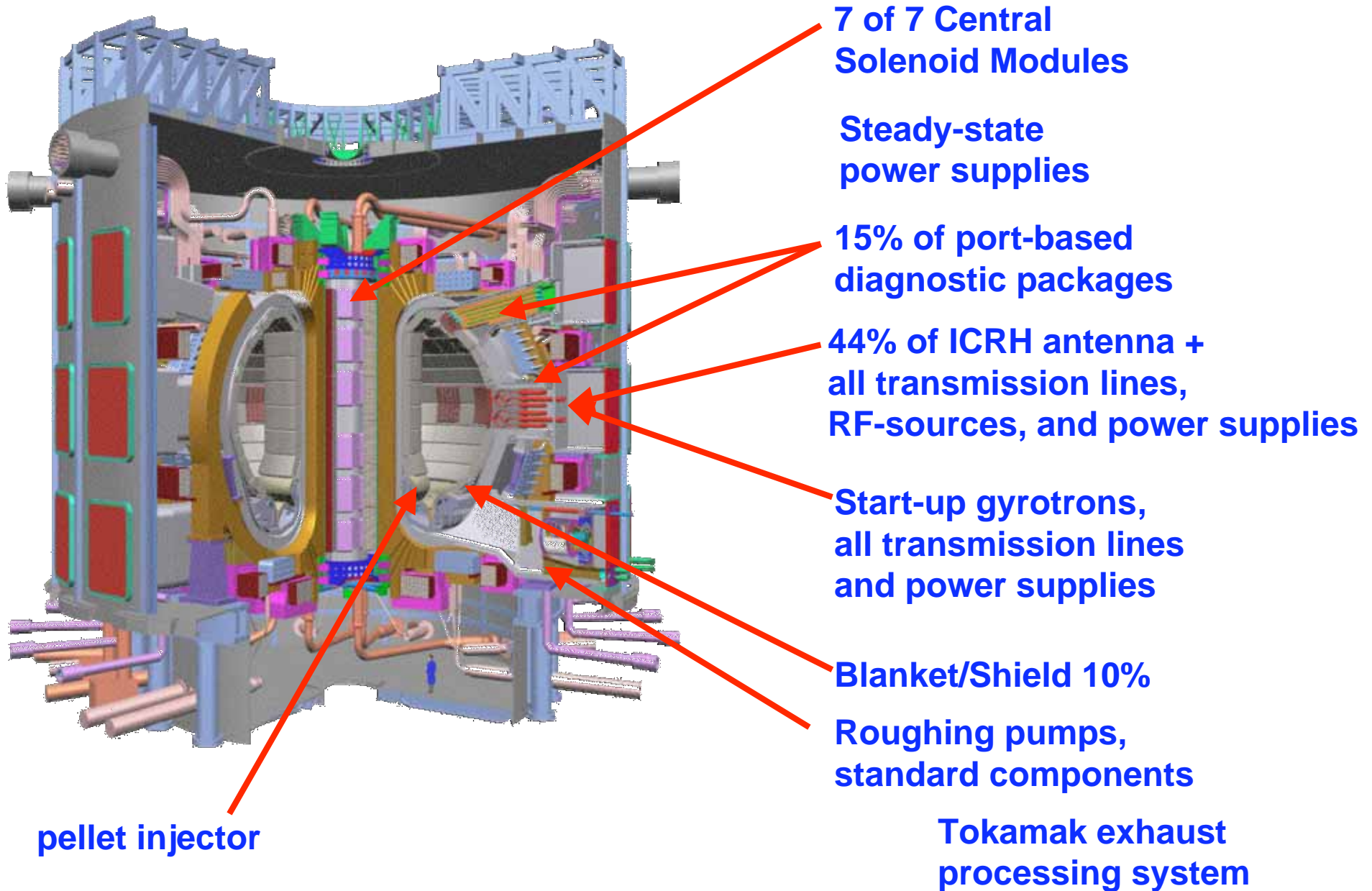

# Magnets

# Magnet system

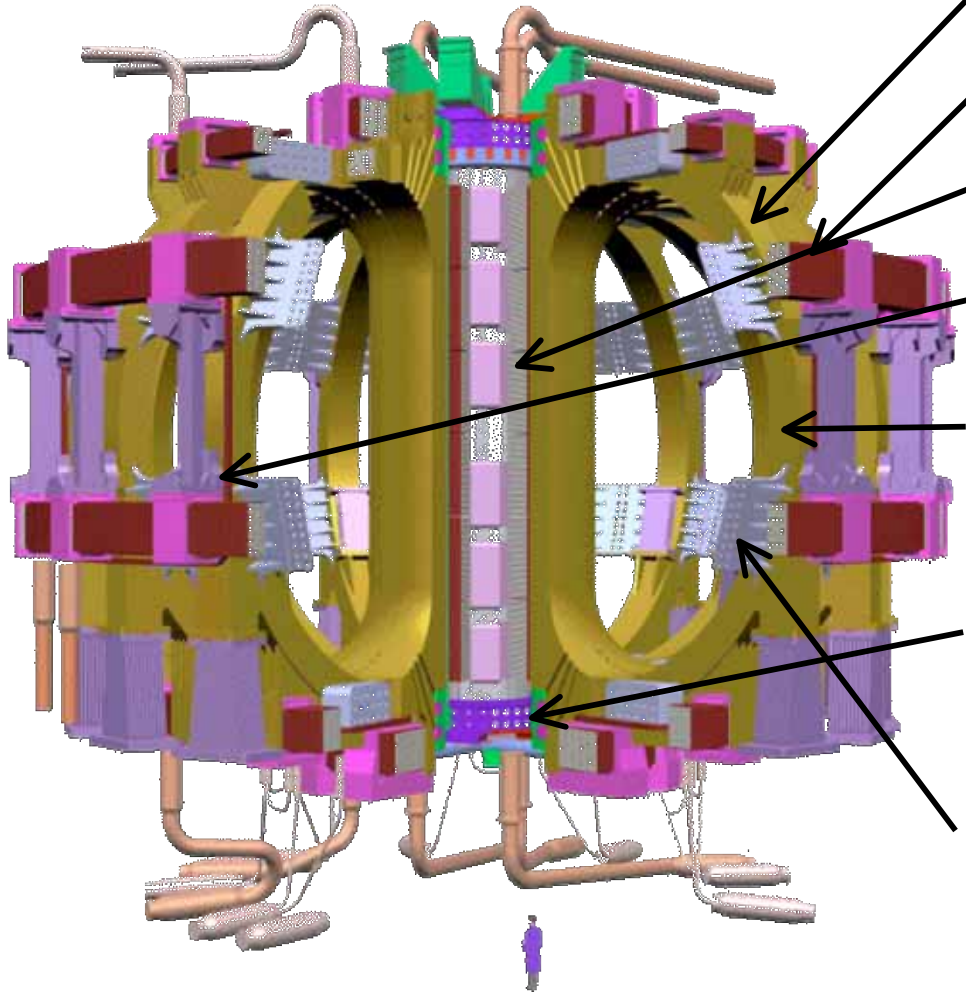

- Superconducting.
- $\text{Nb}_3\text{Sn}$  toroidal field (TF) coils produce confining/stabilizing toroidal field;
- NbTi poloidal field (PF) coils position and shape plasma;
- modular  $\text{Nb}_3\text{Sn}$  central solenoid (CS) coil induces current in the plasma.
- correction coils correct error fields due to manufacturing/assembly imperfections, and stabilize plasma against resistive wall modes.
- TF coil case provides main structure of the magnet system and the machine core. PF coils and vacuum vessel are linked to it. All interaction forces resisted internally.
- TF coil inboard legs wedged together along their side walls and linked at top and bottom by two strong coaxial rings which provide toroidal compression and resist the local de-wedging of those legs under load.
- On the outboard leg, out-of-plane support provided by intercoil structures integrated with TF coil cases.
- Magnet system weighs ~ 8,700 t.

# ITER Magnet System

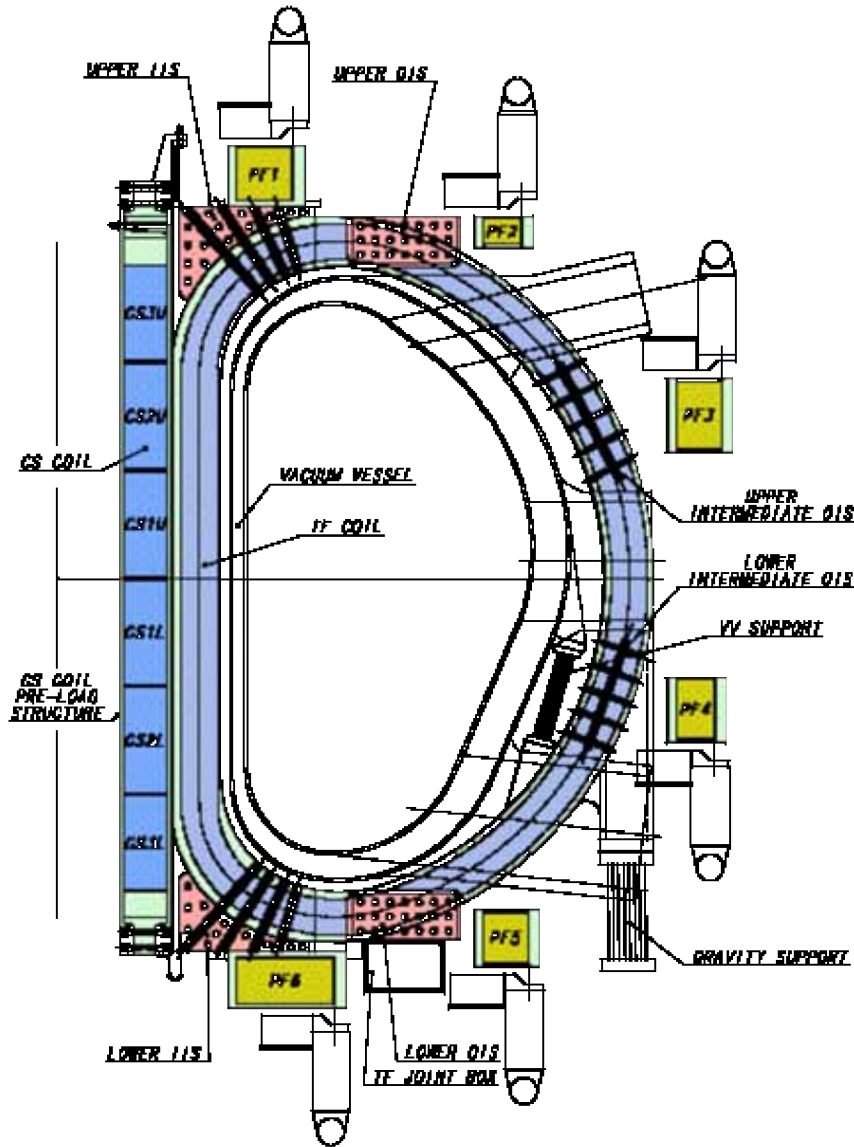

TF coils: #, stored energy, max field; conductor is Nb <sub>3</sub> Sn CICC	18, 41 GJ, 11.8T
CS coils: #, stored energy, max field; Conductor is Nb <sub>3</sub> Sn CICC	6, 6.4 GJ, 13T
PF Coils: #, max field, Conductor is NbTi	6, 6.4T
<b>CS COIL SYSTEM</b>	
$I_{\text{conductor}}$	46 kA
dB/dt	1.3 T/s
Volt-second swing	277 Wb
Total Mass CS/ Magnet System system	~840t / 9,000 t

# Magnet system : PF+CC

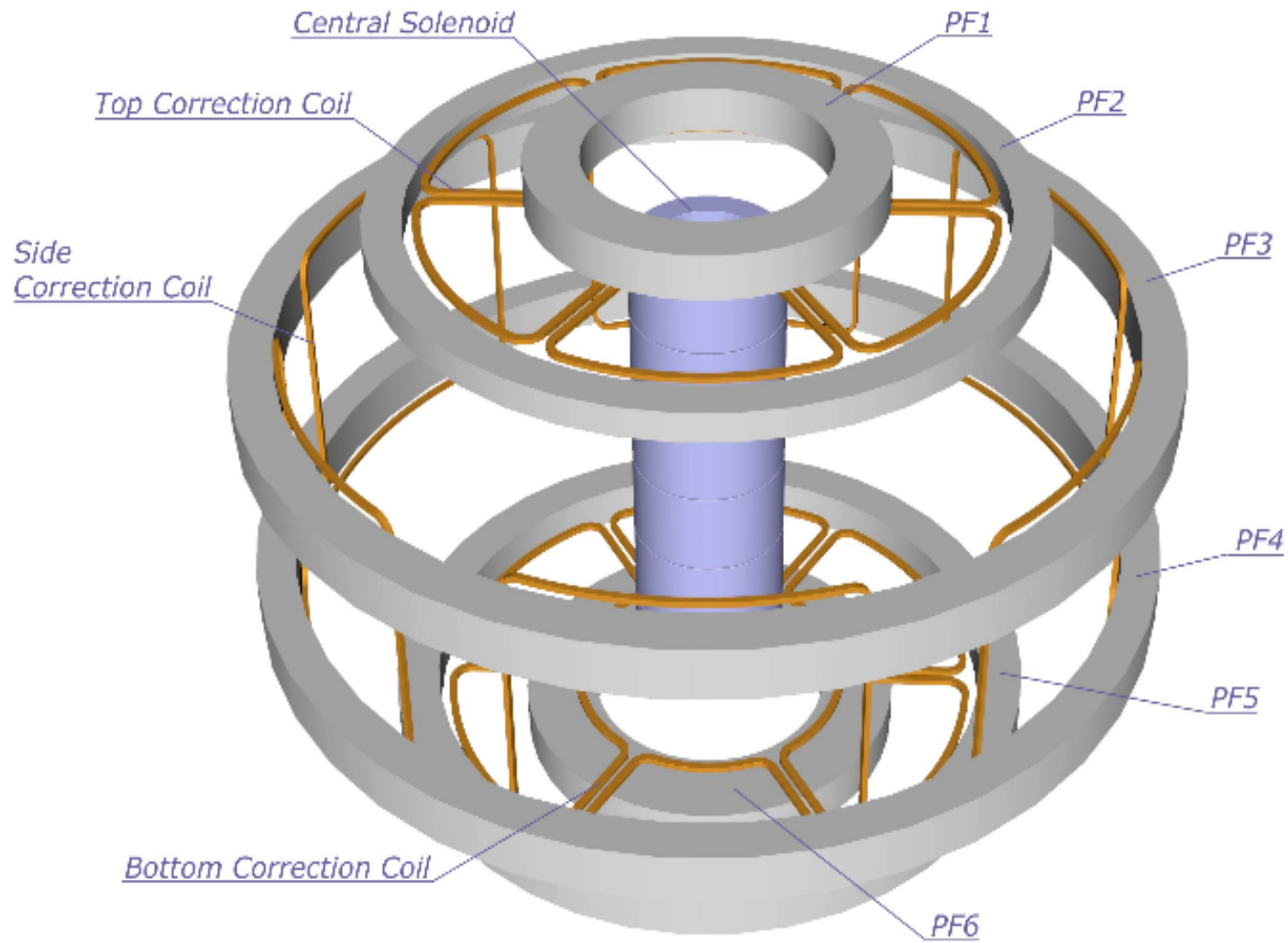

## Central Solenoid Model Coil

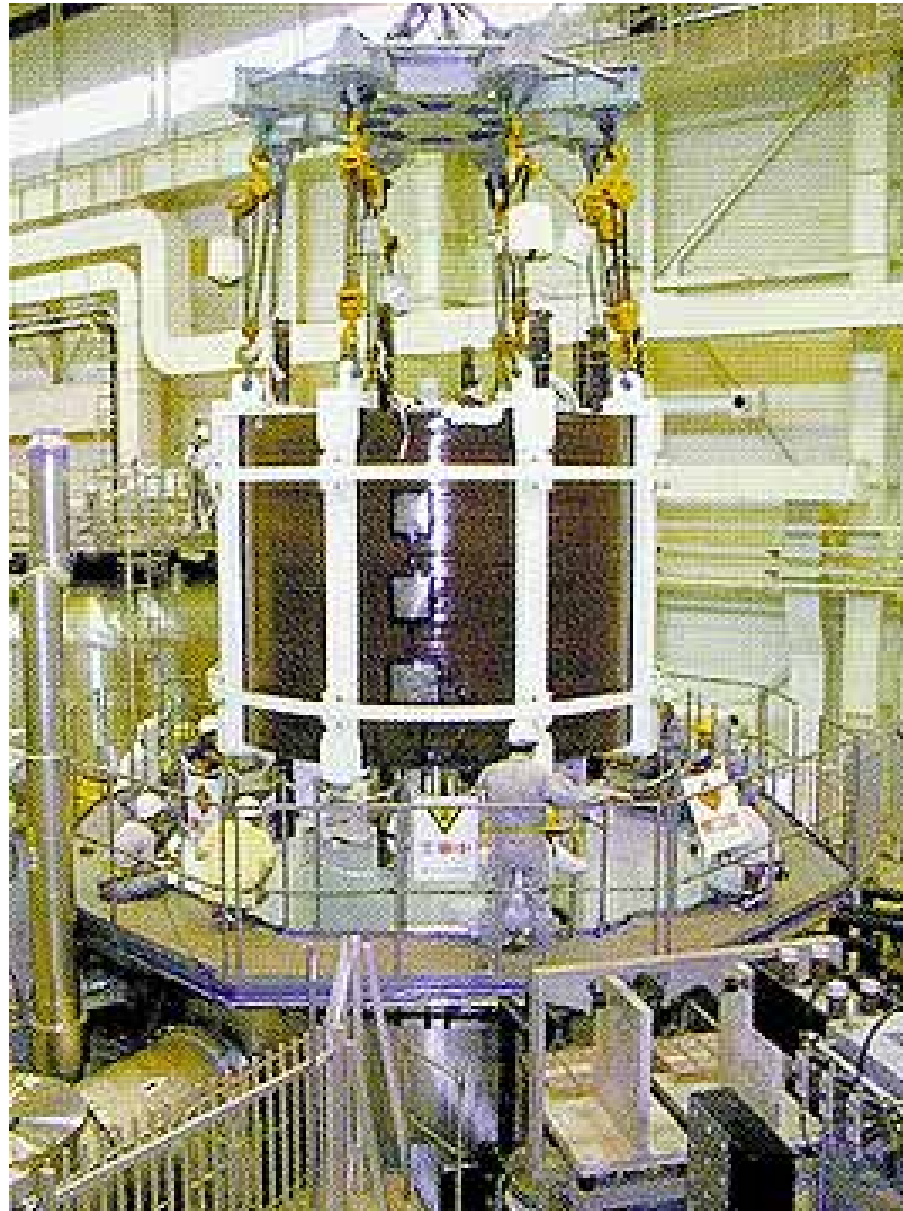

Radius 3.5 m

Height 2.8m

$B_{\max} = 13 \text{ T}$

$W = 640 \text{ MJ}$

0.6 T/sec



## Toroidal Field Model Coil



Height 4 m  
Width 3 m  
 $B_{\max} = 7.8 \text{ T}$   
 $I_{\max} = 80 \text{ kA}$

# CS Magnet Assembly

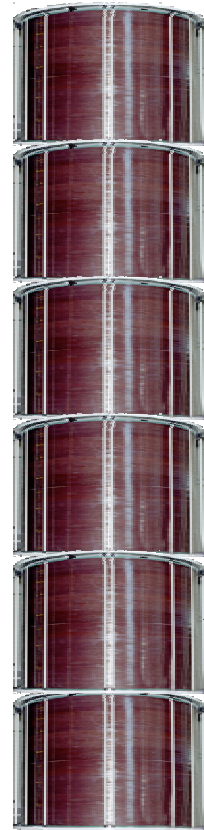
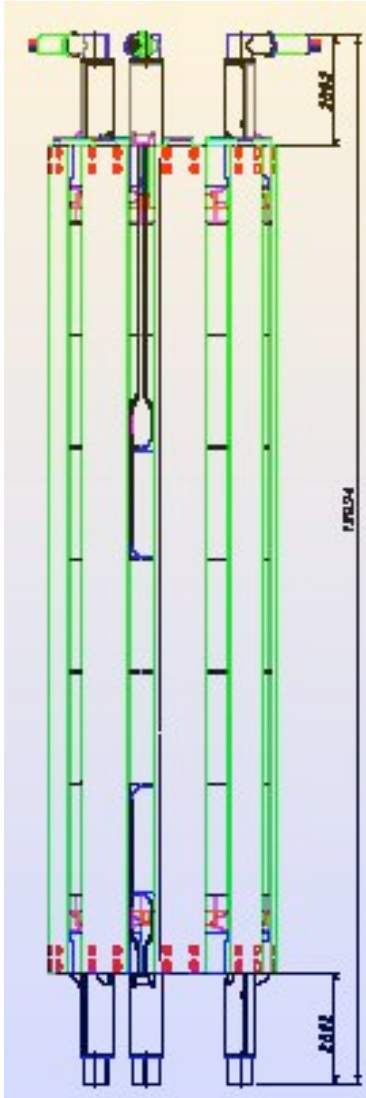

- **CS Assembly includes:**

- 6 identical modules
- Composite inter coil spacer Structures
- Axial pre-compression system
- Sets of axial upper and lower current and cryogen feeders

- **CS main interface is the TF System:**

- CS mounts off the upper TF coil cases
- TF sets the radial build constraint of CS



**Each module is slightly larger than CSMC**

# CS Module and Major Components

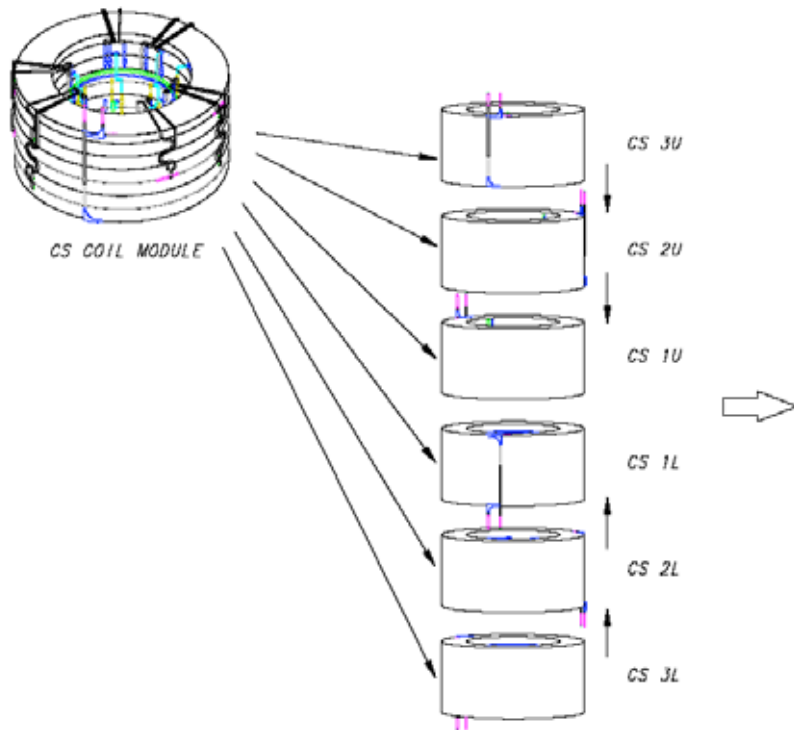

- Module Fabrication:
  - All 6 modules are identical
  - 60° module indexing at assembly
  - Each Module:
    - ~5900m of conductor
    - 1 quad [4 layer] and 6 hexa [6 layer] pancakes
  - In line butt joints between pancakes
  - He stubs and local coil leads included in scope

## CS Readiness For Construction

- During the ITER EDA the Central Solenoid Model Coil was constructed as a major R&D component
  - US and Japan were major partners
  - US manufactured Inner Module, structure and bus bars
  - Many major fabrication methods were developed and successfully implemented
  - Present ITER CS design uses pancake instead of layer winding

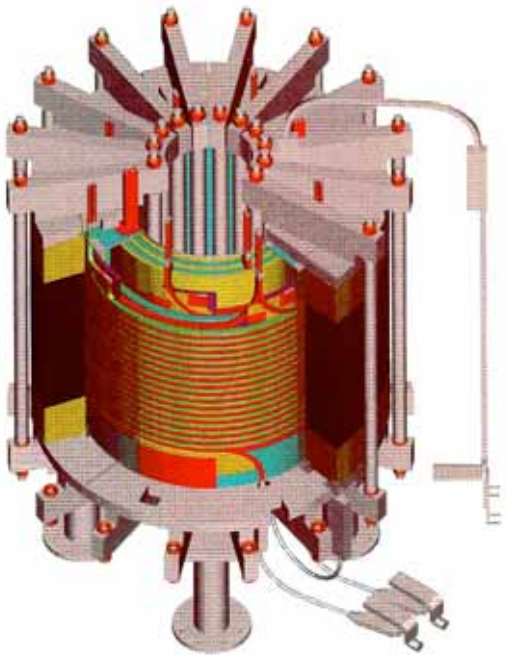

The CSMC was successfully tested during 3 test campaigns in 2000-2002

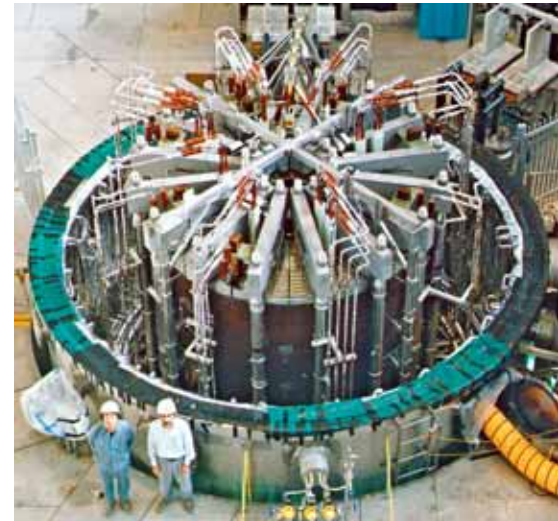

# Qualification of industrial suppliers of Nb<sub>3</sub>Sn strands with increased value of J<sub>c</sub>

- **FY04**
  - ordered 100kg lots of strand from 3 vendors at 1000 A/mm<sup>2</sup>
- **FY05**
  - Test the 100kg lots (including contracts with NIST and UWisconsin)
- **FY06**
  - Procure somewhat higher quantity strand from successful vendors with processes extrapolable to production quantities and lower cost/kg
  - Test the larger quantity prototypes to enable qualification of strand vendors

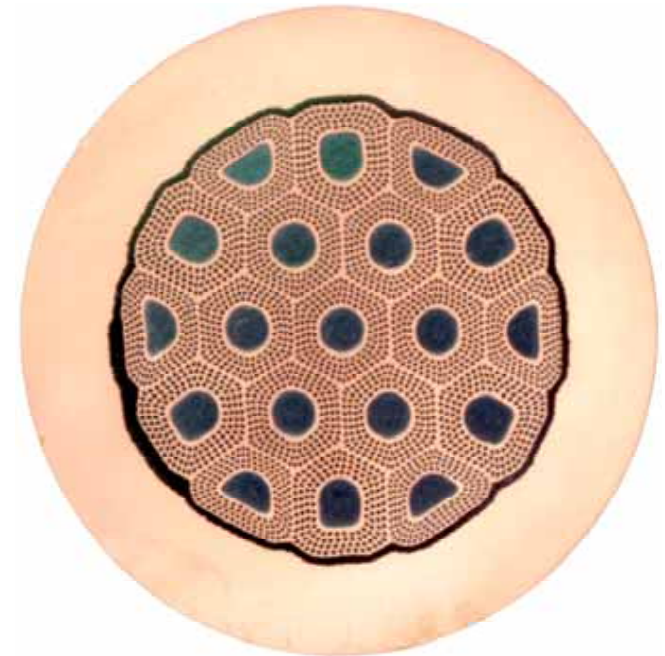

Typical strand layout as proposed by OST. Diameter is ~0.8 mm.

# Conductor Performance and Design Criteria

- Test transverse load effects on the conductor
- Test and seek understanding of degradation of performance, to form the basis for design criteria



**Vacuum  
Vessel**

# Plasma Vacuum Vessel

- **Primary function**
  - high quality vacuum for the plasma
  - first confinement barrier to radioactive materials
- **9 x ~40° vessel sectors.**
- **Many ports for access**
  - Diagnostics
  - Maintenance
  - Heating systems
  - Fuelling/Pumping
  - Inspection
  - Test Blankets
- **Double wall**
- **Water cooled**

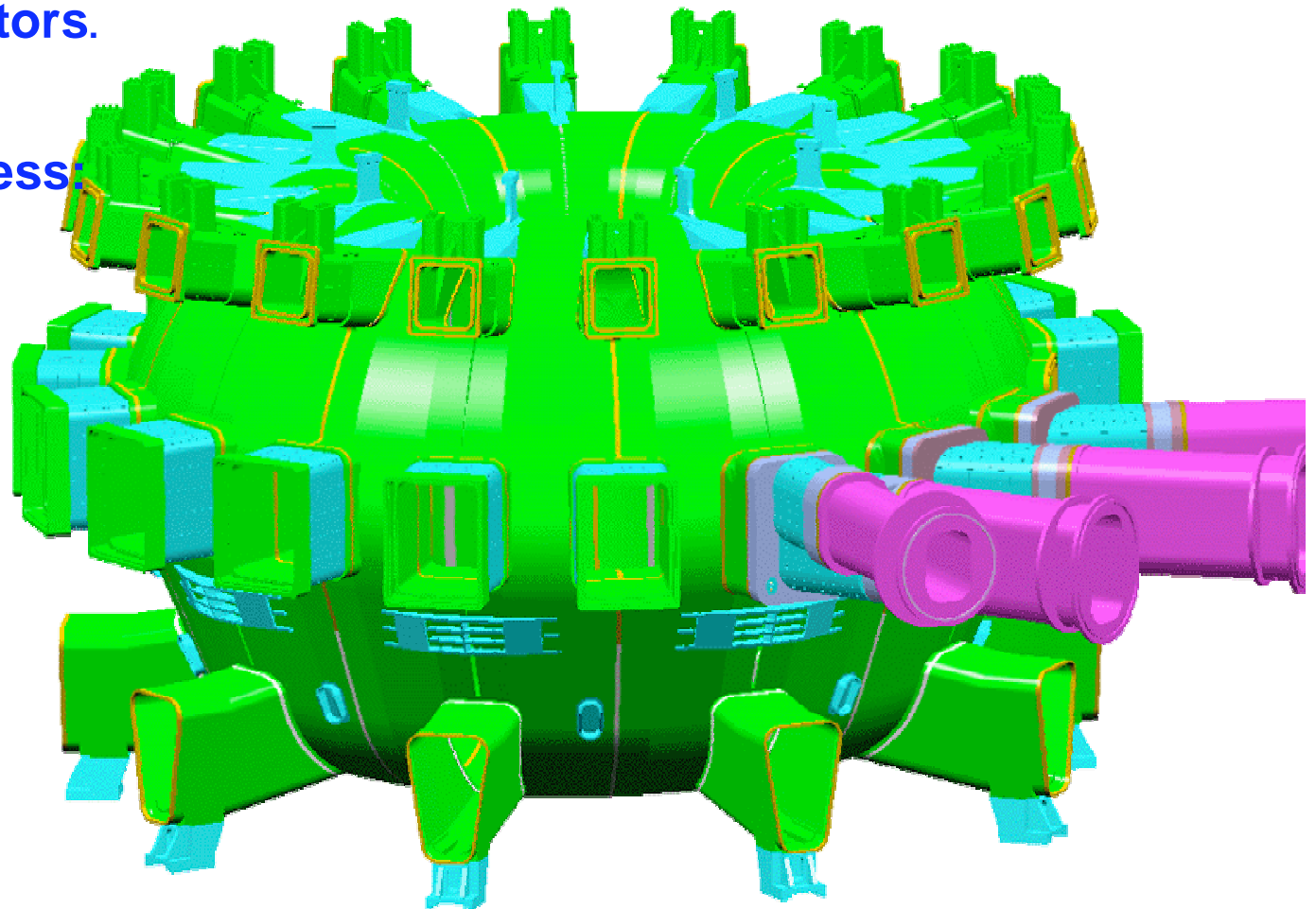



# Vacuum Vessel Sector

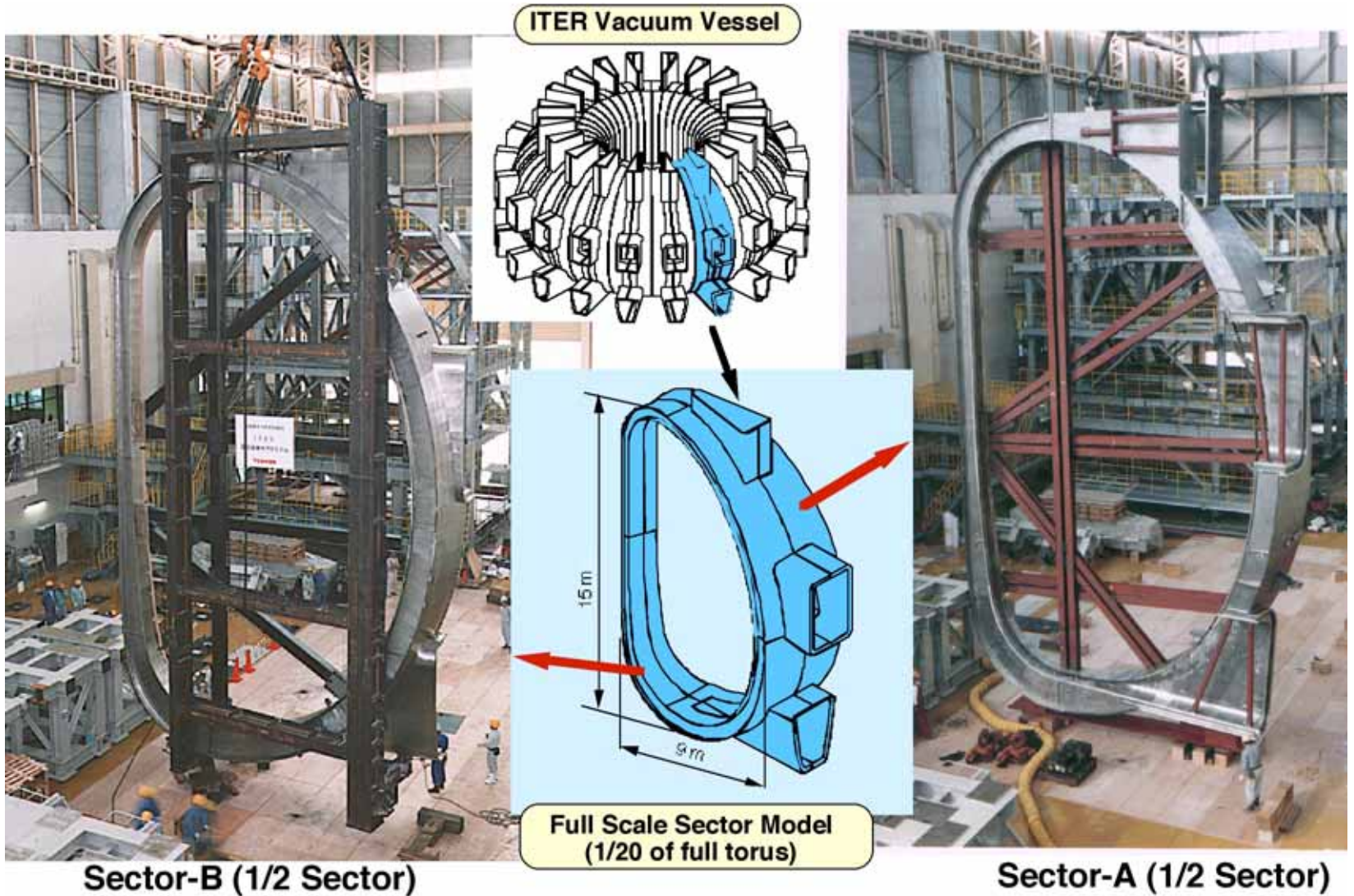

**View of full-scale sector model of ITER vacuum vessel completed in September 1997 with dimensional accuracy of  $\pm 3$  mm**

**First Wall /**

**Shield /**

**Blanket**

# Physics Integration with ITER Plasma-Facing Components

- **Power and particle exhaust**

- must handle 500MW - 1250MW (20% in plasma, 80% in neutrons) for long pulses
  - $\sim 10\text{MW/m}^2$  in the divertor
  - $< \sim 1\text{MW/m}^2$  to the first-wall/shields
- transient events (ELMs [ $0.4\text{MJ/m}^2$ ], disruptions)
- mitigation techniques
- acceptable tritium retention and removal
- studies of high-Z plasma-facing surfaces

- **Energetic particle losses**

- background asymmetries
- energetic particle modes

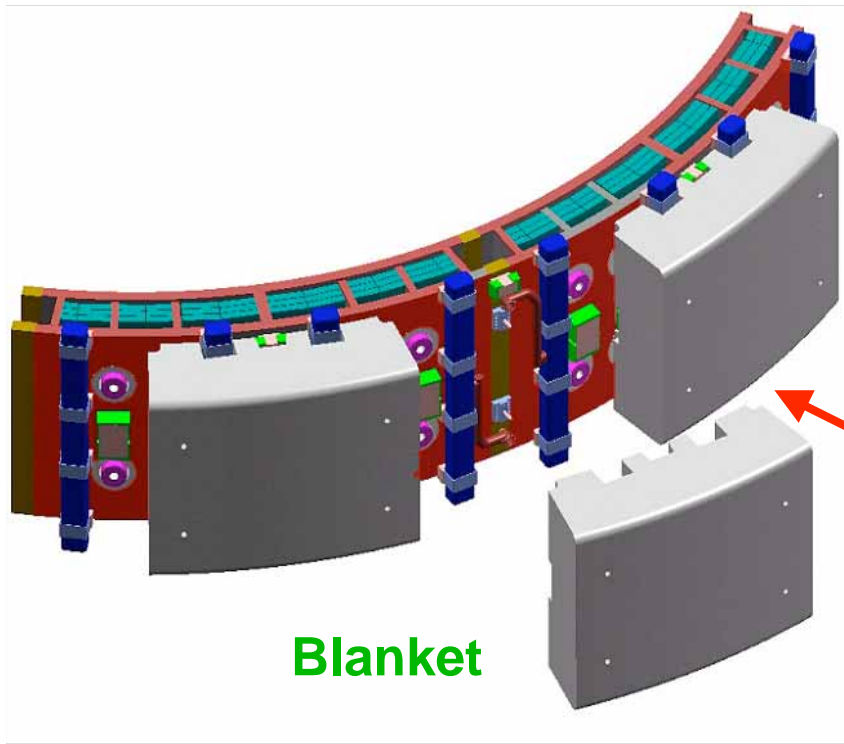

Blanket

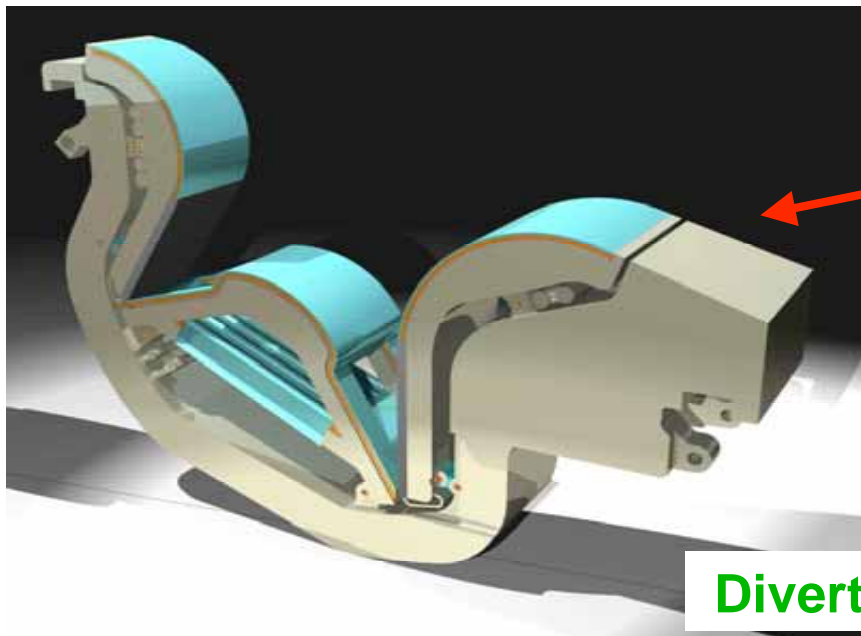

Divertor

Vacuum Vessel

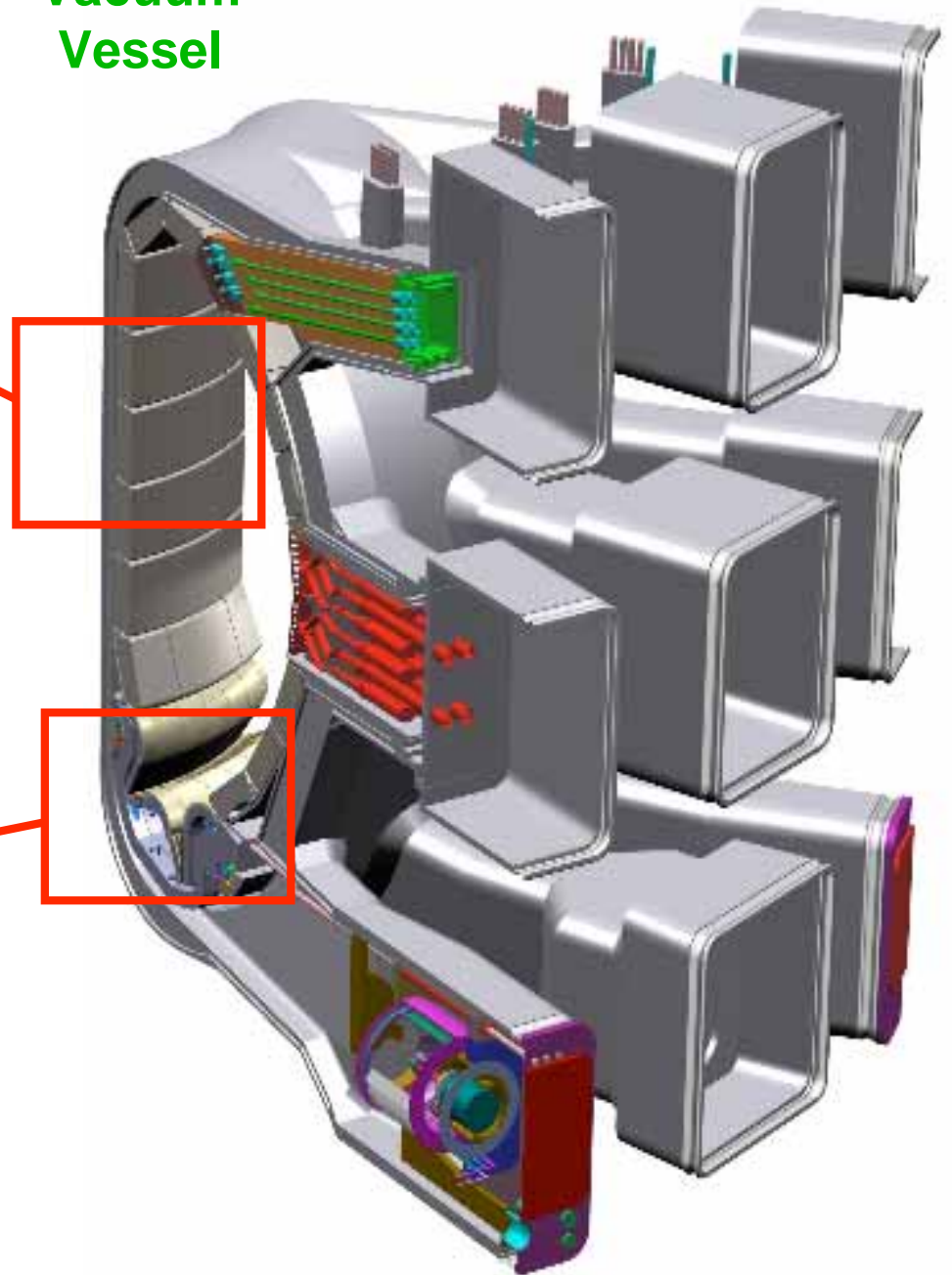

## Shield / Blanket

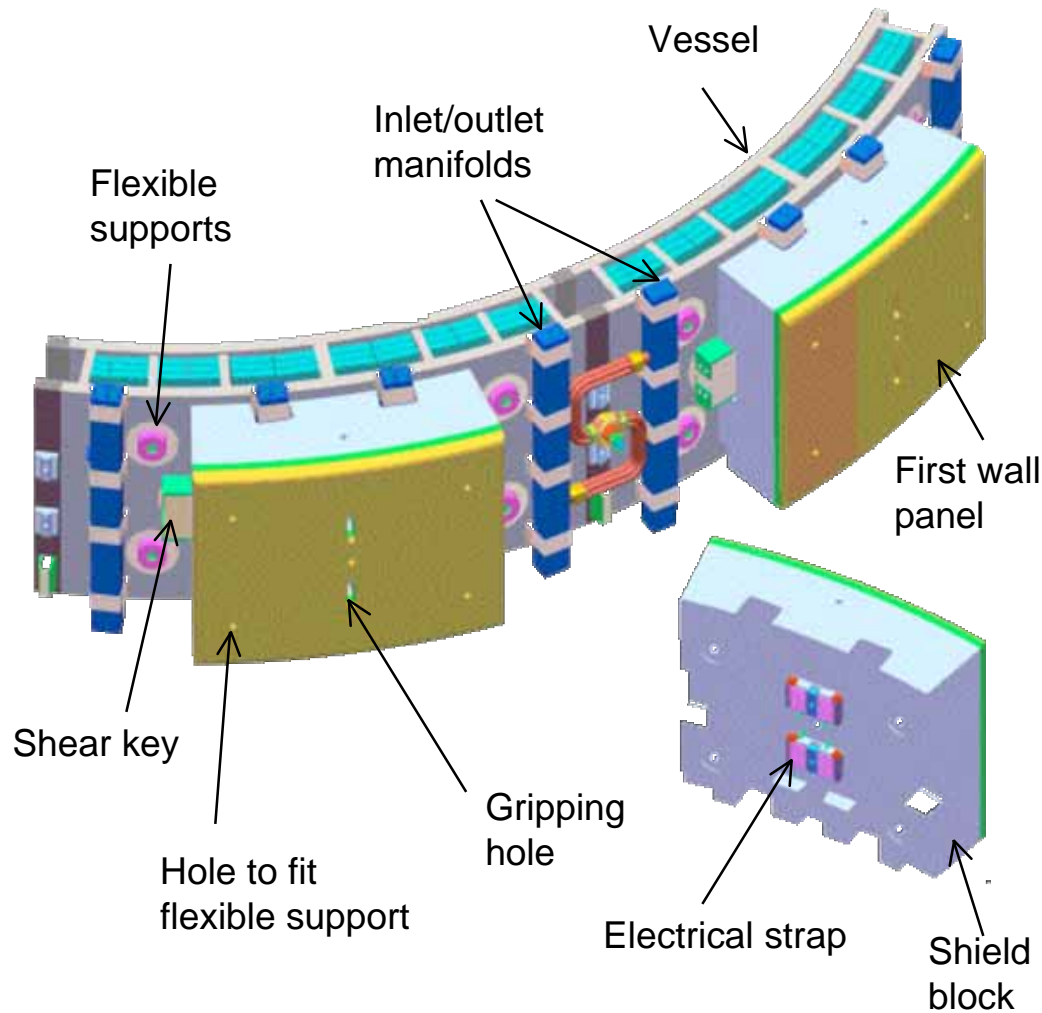

- 421 blanket modules with detachable faceted first wall (FW) with Be armour on a water-cooled copper substrate, attached to a SS shielding block -
- Blanket cooling channels are mounted on the vessel.
- Design strongly affected by need to resist electromagnetic forces.
- Initial blanket acts solely as a neutron shield, and tritium breeding experiments are carried out on test blanket modules inserted and withdrawn at radial equatorial ports.

# Blanket Module



HIP Joining Tech

Size : 1.6 m x 0.93 m x 0.35 m

## Remote Maintenance of Blanket

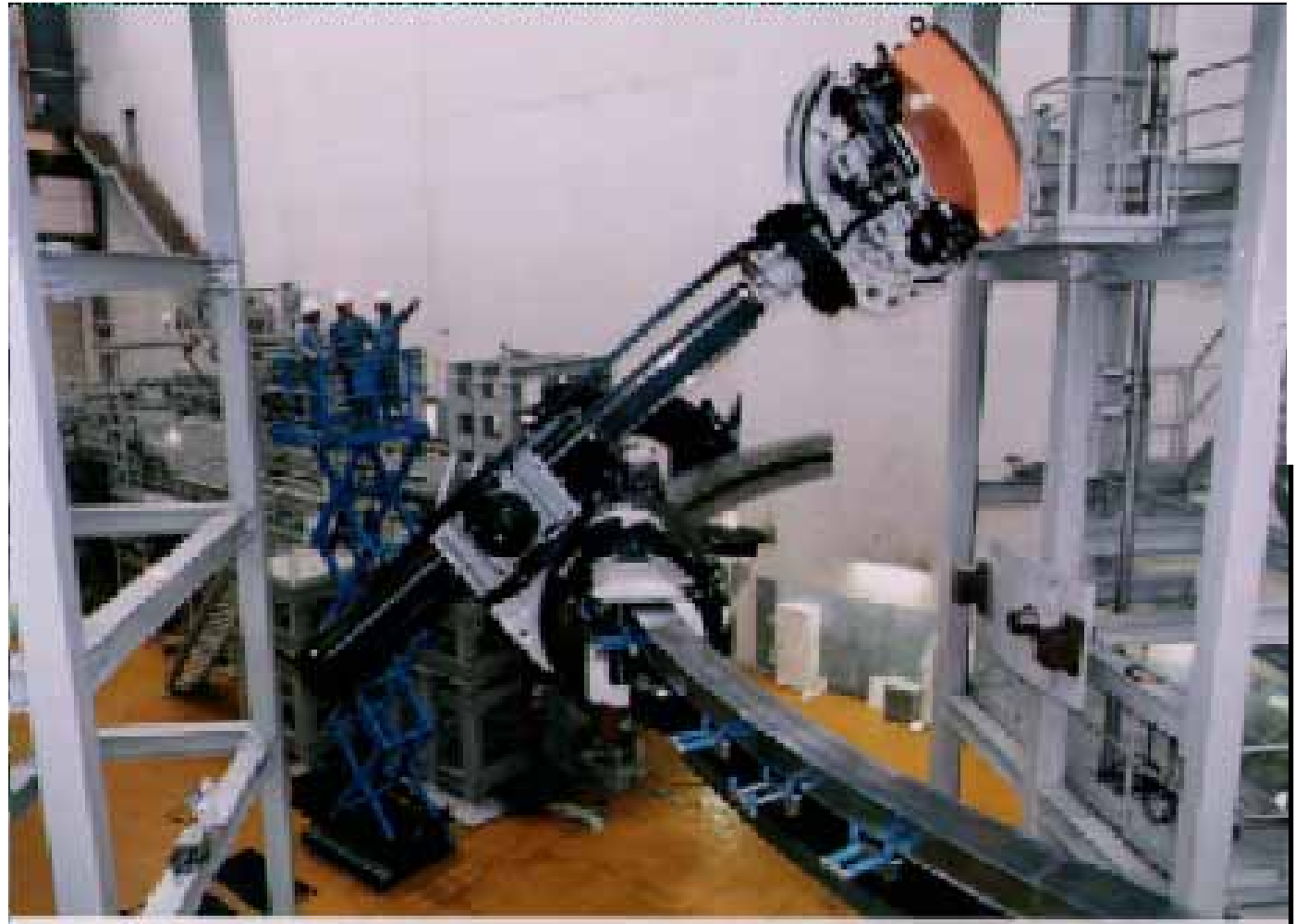

4 t Blanket Sector

Attachment Tolerance  $\pm 0.25$  mm

**Divertor**



# Divertor

- 54 cassettes.
- Target and divertor floor form a V which traps neutral particles, protecting the target plates, without adversely affecting helium removal.
- Design uses C at the vertical target strike points. W is the backup. C is best able to withstand large power density pulses (ELMs, disruptions), but produces tritiated dust and T co-deposited with C which has to be periodically removed. The choice can be made at the time of procurement.

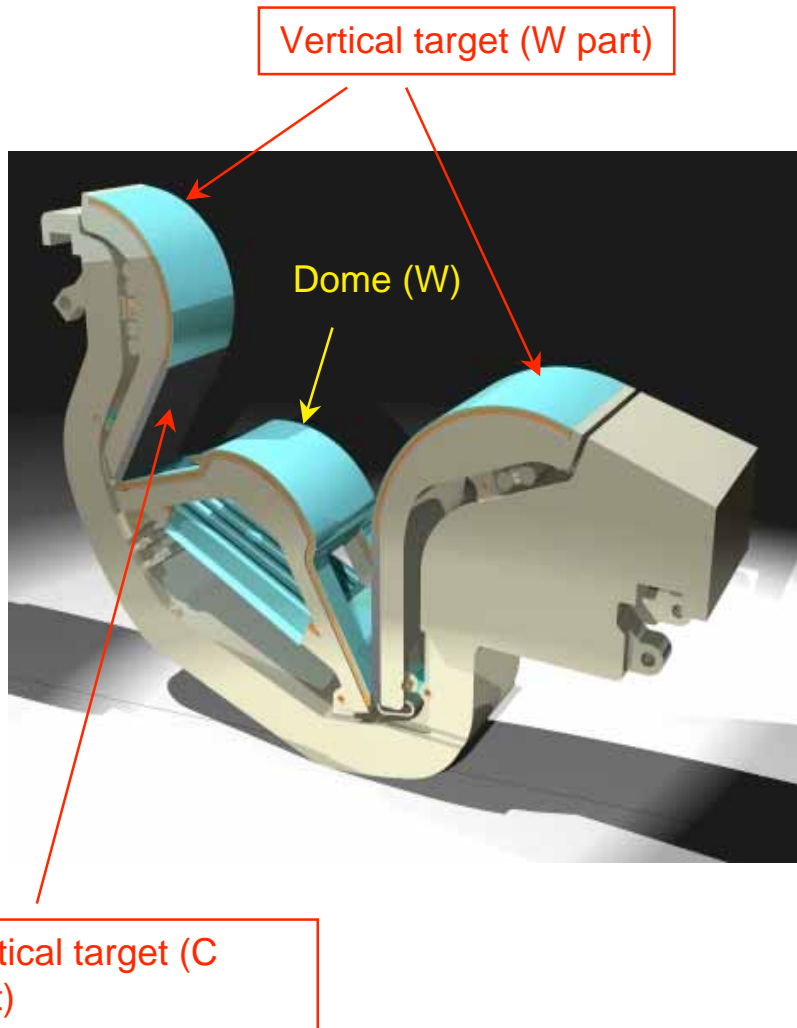

## Divertor Cassette



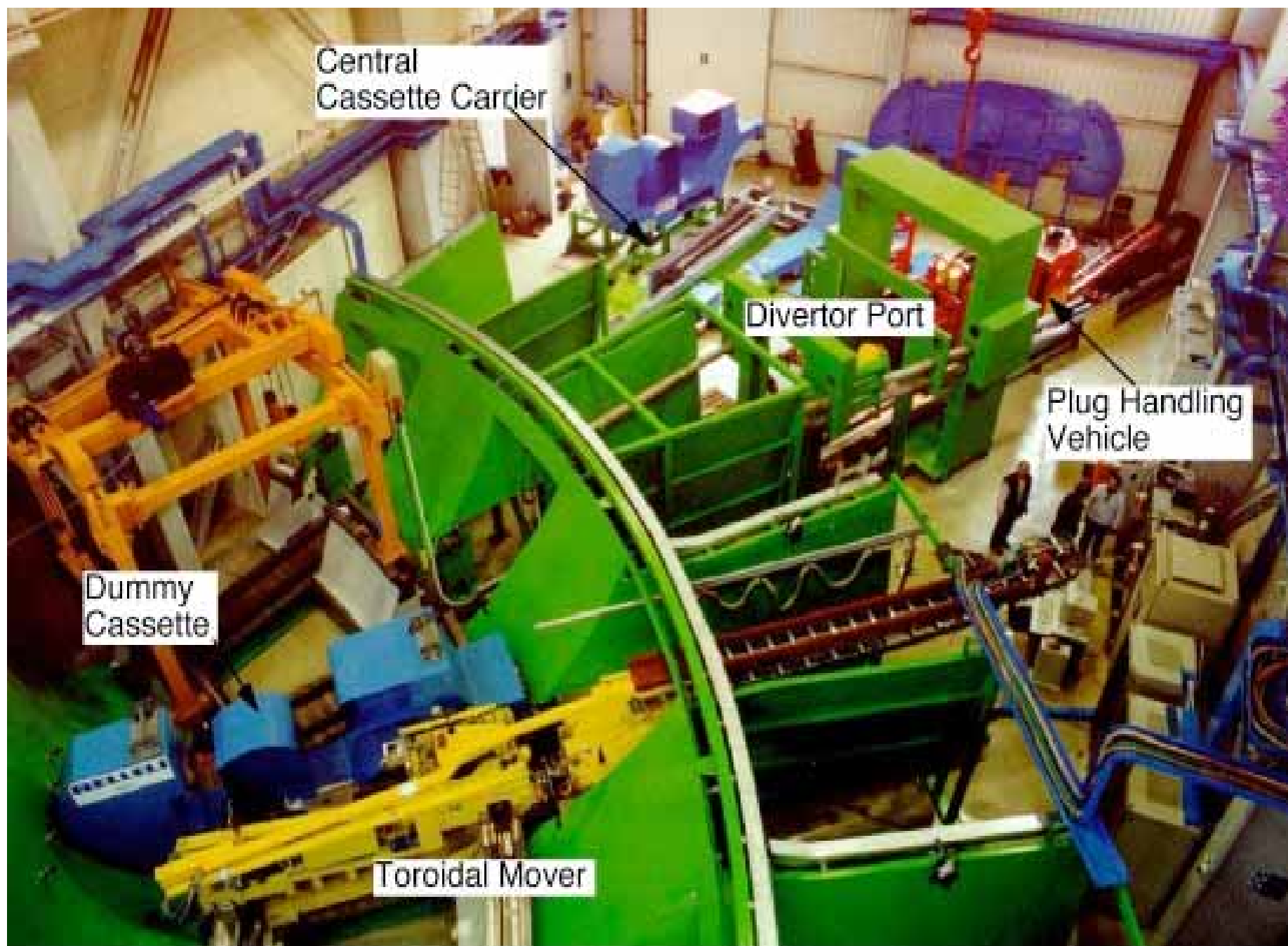

Central  
Cassette Carrier

Divertor Port

Plug Handling  
Vehicle

Dummy  
Cassette

Toroidal Mover

**Ion**

**Cyclotron**

## Heating/Current Drive

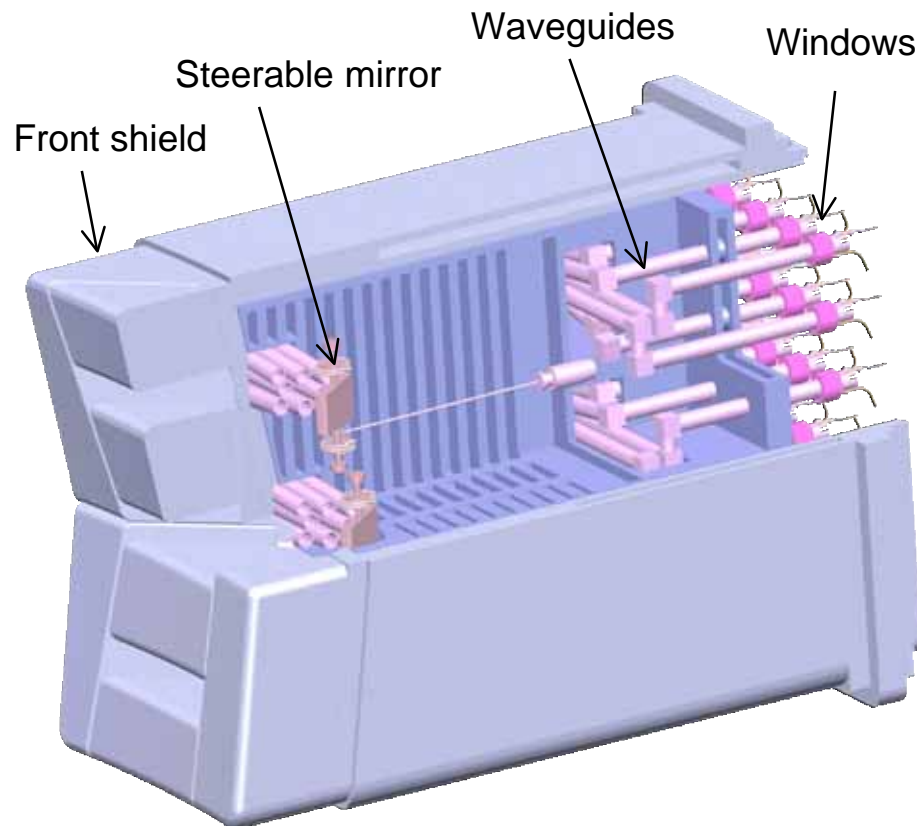

Electron Cyclotron System  
Equatorial Port Plug

- High energy (1 MeV D<sup>-</sup>) ion beams + radio frequency heating tuned to key plasma frequencies (ion, electron cyclotron, lower hybrid);
- RF systems modular and interchangeable in equatorial ports; EC used in upper ports;
- 2 main beam-lines, with room for third;
- Initial installation 73 MW with room for expansion to 130 MW.

# Physics Integration with Ion Cyclotron System

- **53MHz He<sup>3</sup>-minority and second-harmonic tritium**
  - off-axis heating and current drive
- **Coupling to a range of plasmas**
  - steady-state
  - transient
- **$T_e > T_i$  - related increase in Landau and cyclotron damping**
- **Alphas modify the wave dispersion and dissipation (and maybe mode conversion)**
- **Rotation drive?**
- **Formation of energetic population?**
- **Wave-induced transport? Alpha-channeling?**
- **Plasma-facing component issues, neutronics and thermohydraulics**

*International Thermonuclear Experimental Reactor*

# ITER

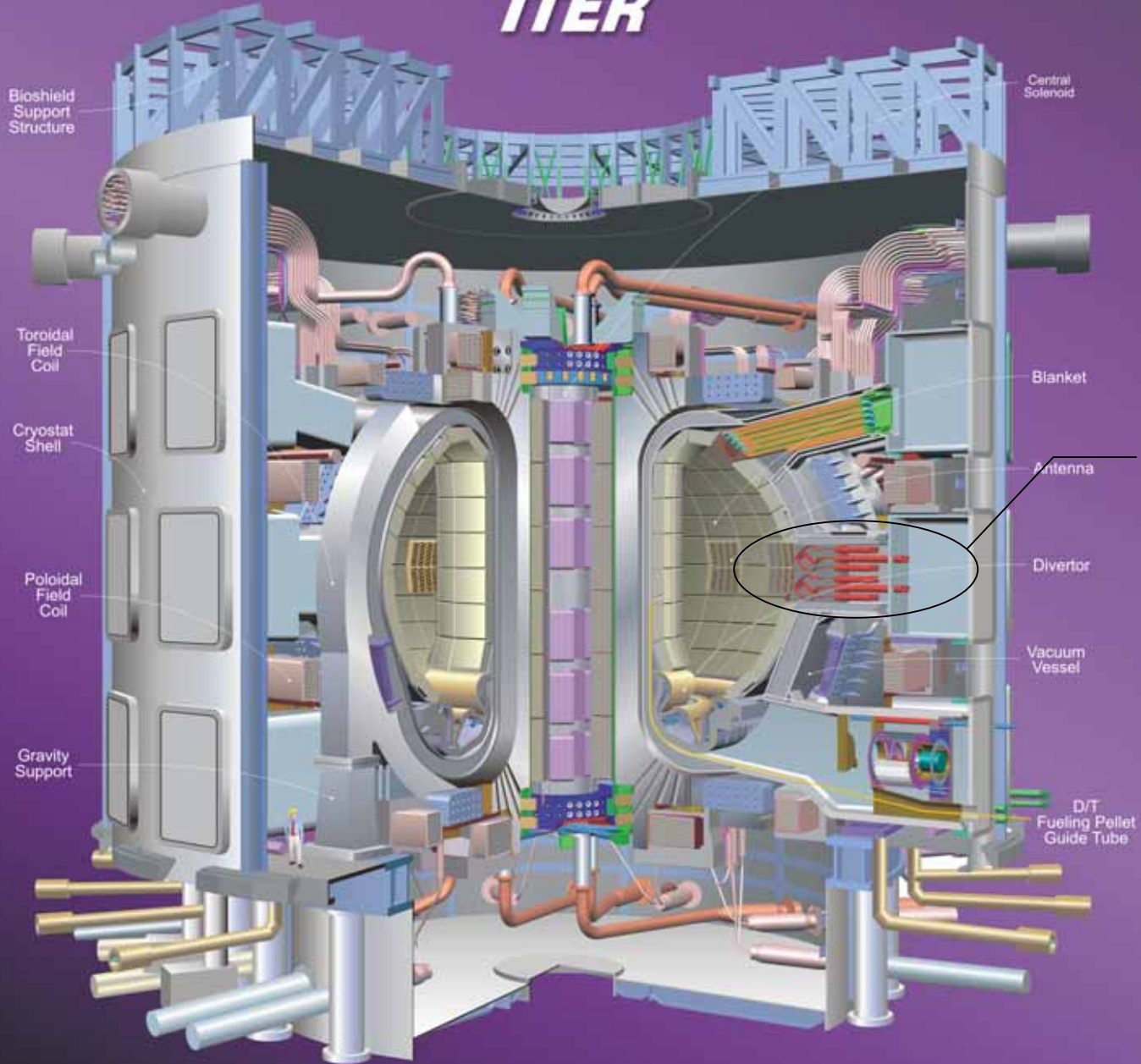

ICH  
Antenna

# What is the ITER ICH system and what does it do?

- **What it is:**

- 20 MW plasma heating system
- One antenna with multiple current straps
- RF sources, each one feeding a current strap
- Tuning elements for a frequency range of 35-65 MHz

- **What it will be used for:**

- Tritium ion heating
- Minority (He, D) ion heating
- Plasma current drive near plasma center
- Plasma current drive off center (ie. at the sawtooth inversion radius)

## ITER Ion Cyclotron Heating (ICH) system block diagram

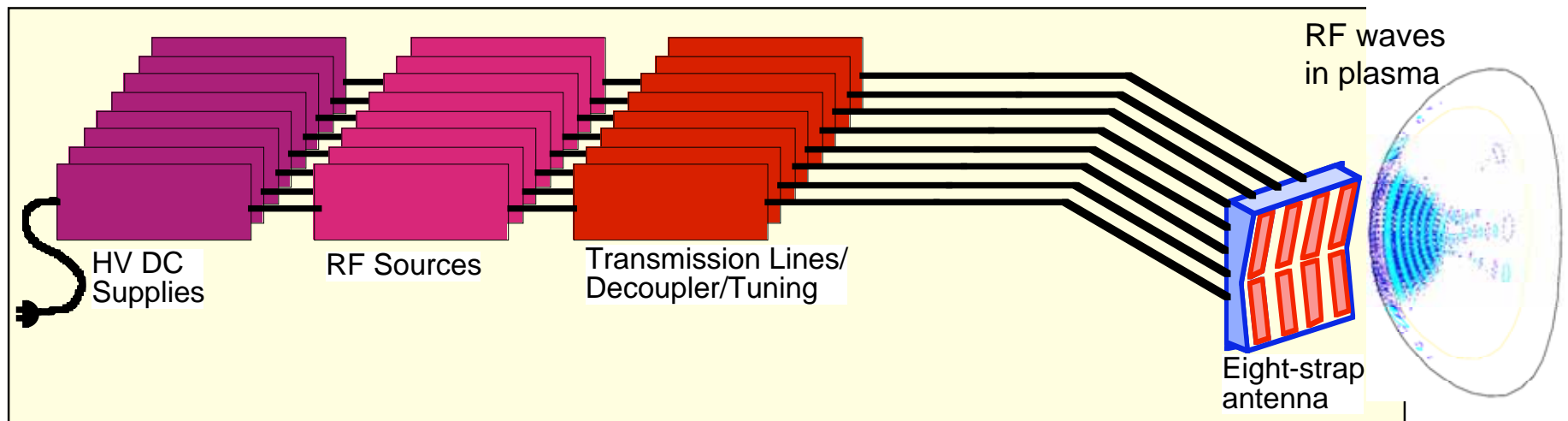



# Overall configuration

- **DC supplies and RF Sources**

- 1 prototype and 8 or 12 production units
- 2.5 MW or 1.7 MW each
- efficiency > 65%
- 35-65 MHz frequency range

- **Transmission line/tuning systems**

- 8 or 12 water cooled coax lines
- 1000 m total length
- High power matching components
- 2 High-power (5 MW) dummy loads

- **Antenna and port plug**

- One antenna with independent current straps
- FDR has “place holder”, but EU/US agree improvements are possible.
- Requires significant additional design effort and R&D

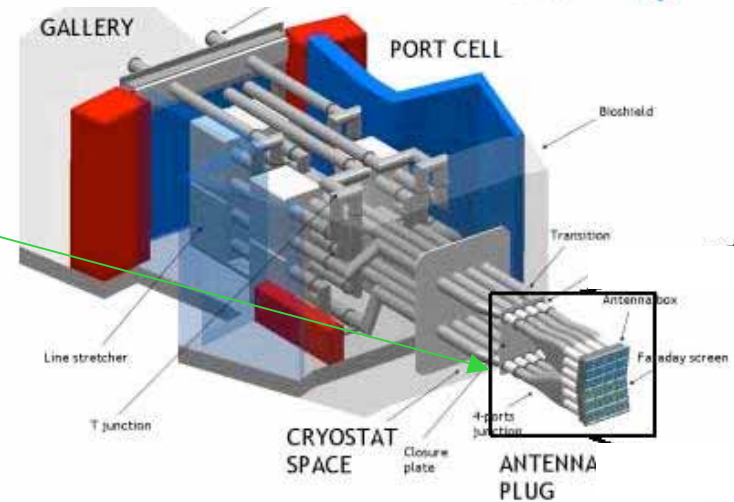
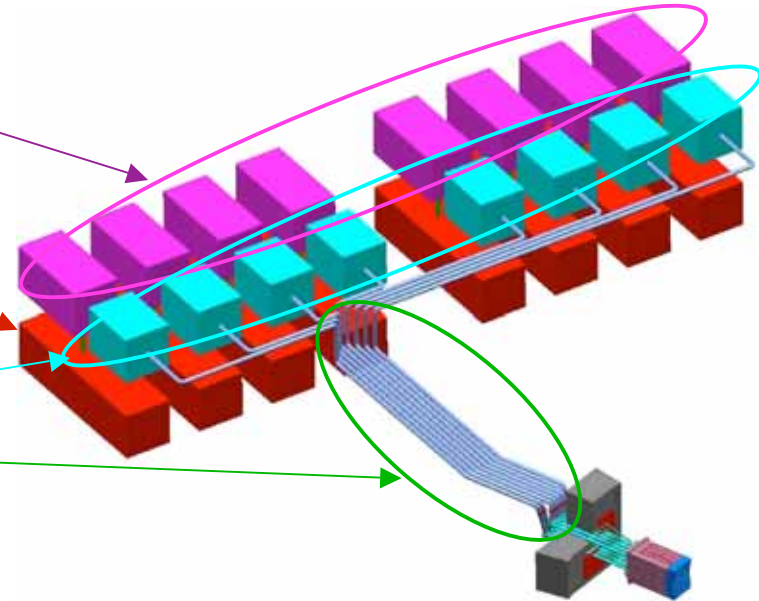

# Transmission line procurement package - US 100%

- **Package scope and information reasonably complete**
- **Transmission line/decoupler/tuning systems**
  - 8 or 12 water cooled coax lines, 1000 m total length
  - High power matching components, 2 High-power dummy loads
  - Components are fairly standard, supplied by several US vendors
- **Primary tasks are writing specs, monitoring fabrication and testing**
- **Cost estimate based on procurements of similar items at PPPL & DIII-D**
- **Degree of risks varies with 8 (baseline) or 12 sources**
- **8 Source option risks:**
  - Development of high power (5 MW) hybrid decoupler, tuners, DC breaks, coax switches and loads
- **12 Source option risks**
  - Development of high power (3.3 MW) hybrid, tuners, DC breaks, coax switches and loads



Coaxial line and tuners



## Antenna procurement package - US 50% EU 50%

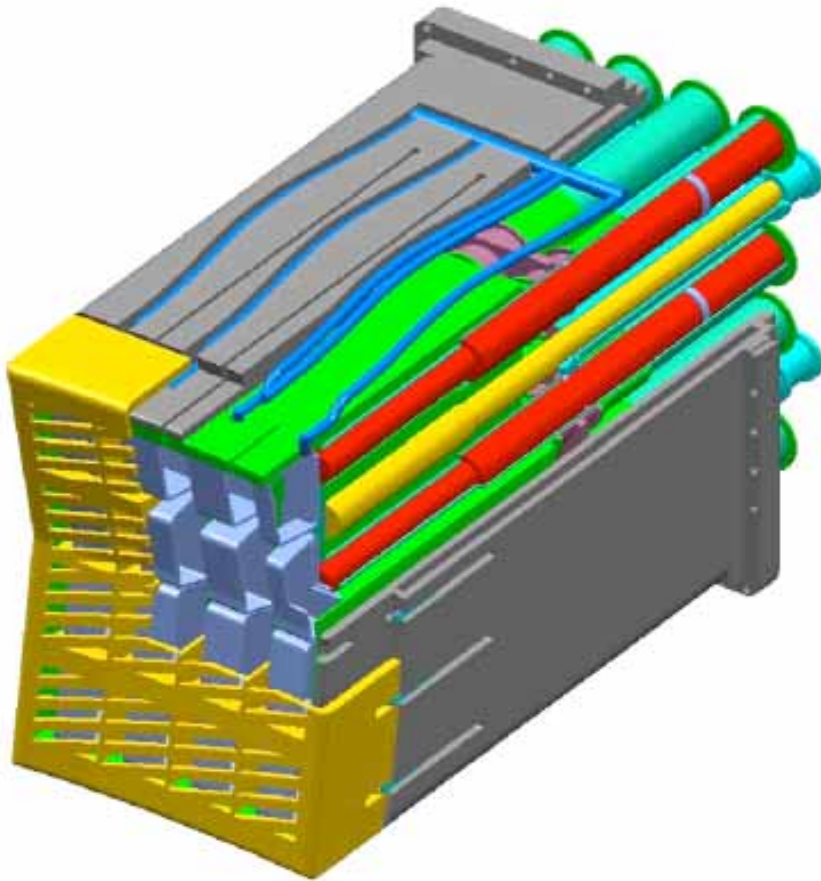

Baseline

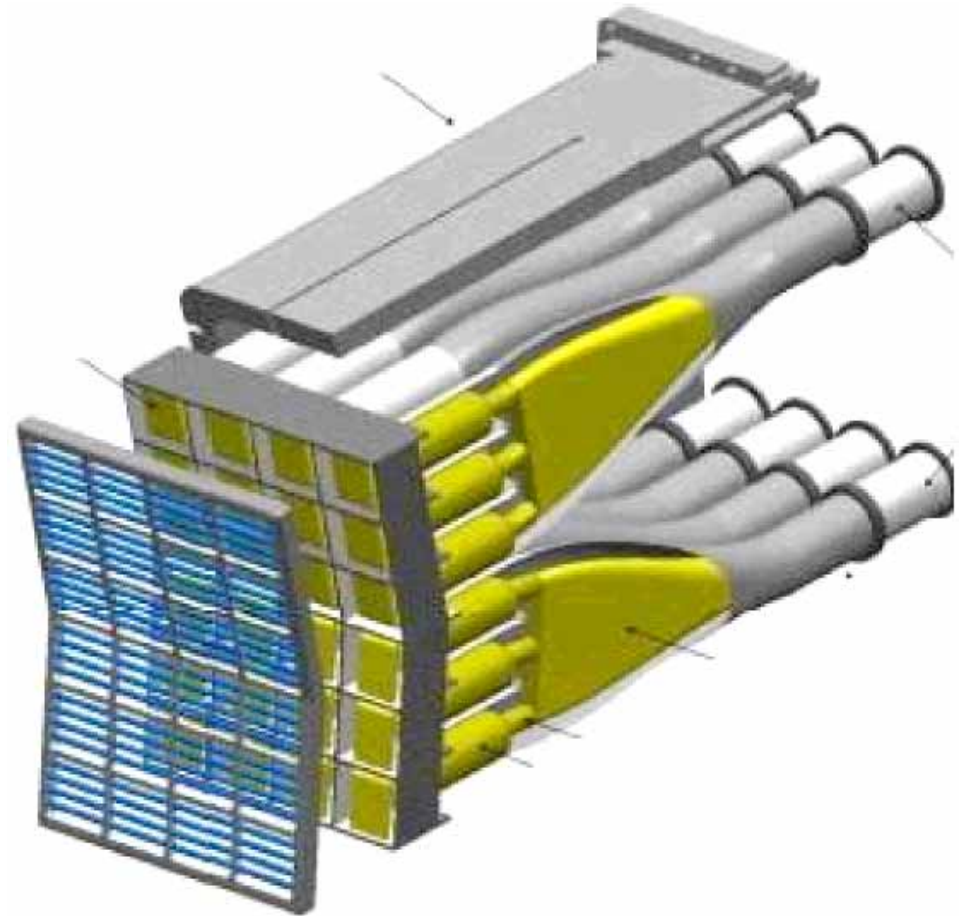

Possible  
alternative

# Electron Cyclotron

# ECH&CD System Ports

## Ports for ECH&CD

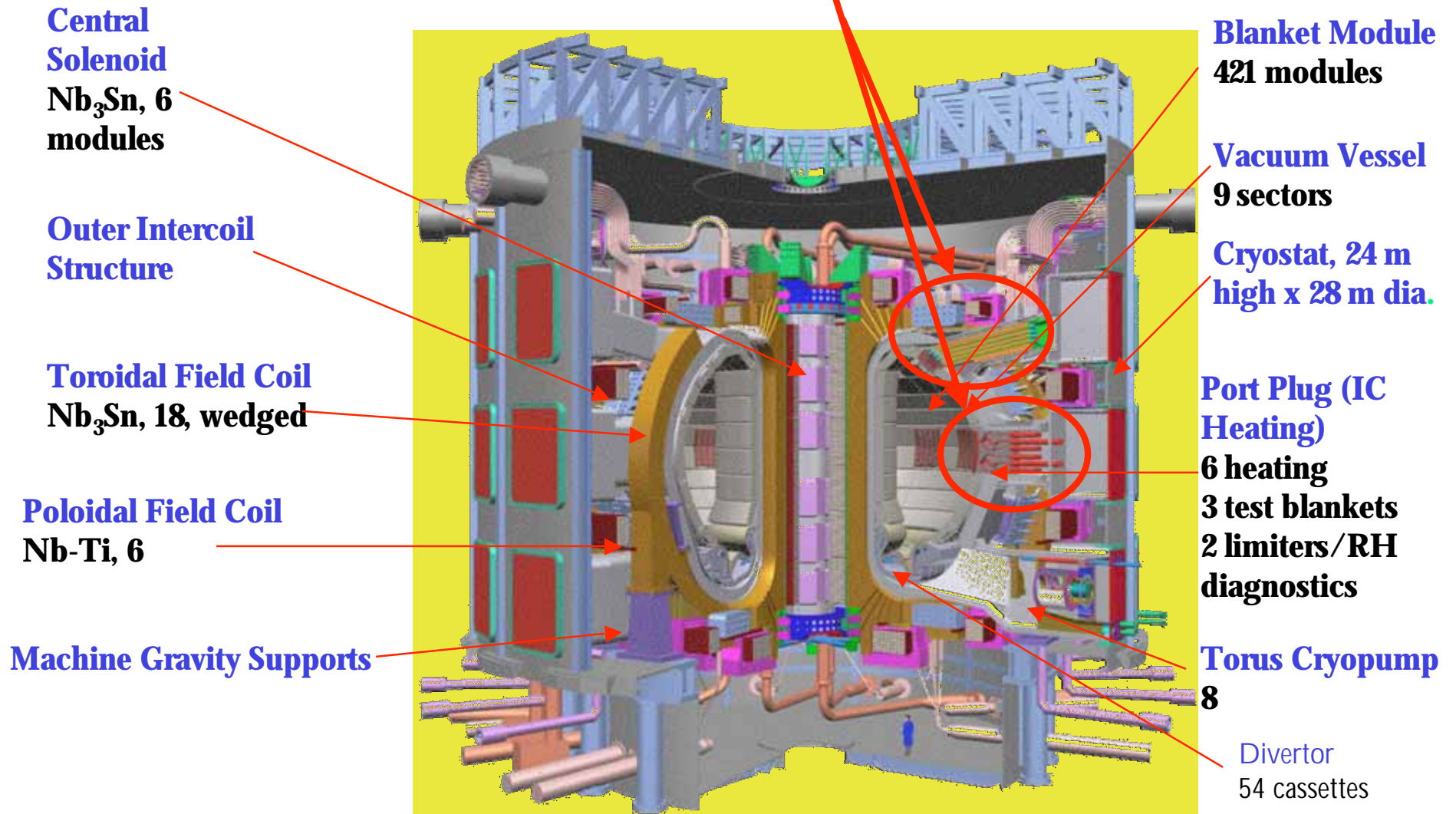

# Electron Cyclotron System Configuration

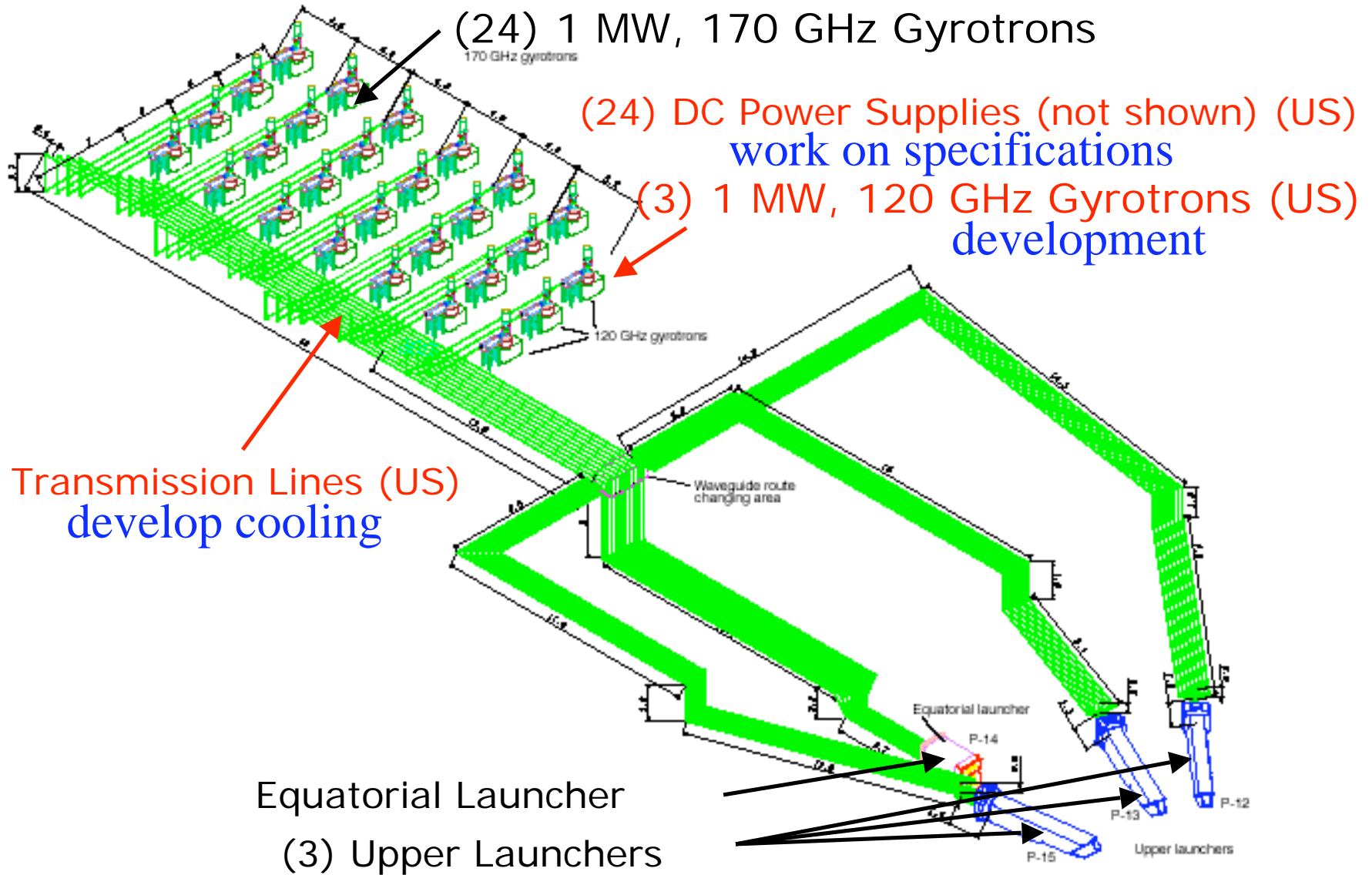

## ECH&CD Technology: Status / Maturity



**1 MW, 110 GHz Gyrotron  
at General Atomics**

- ❑ 1 MW, 110 GHz Gyrotron System at GA
  - Operates for 10 s pulses
- ❑ Gyrotron with oil tank, controls, water distribution, transmission line, dummy load

❑ **CPI 140 GHz Gyrotron operating at 0.8 MW for 30 minutes at Greifswald / W7-X.**

- ❑ Does not meet efficiency spec.
- ❑ Need gyrotron R&D



**Vacuum /  
Fueling**



# ITER Pumping and Fueling Systems

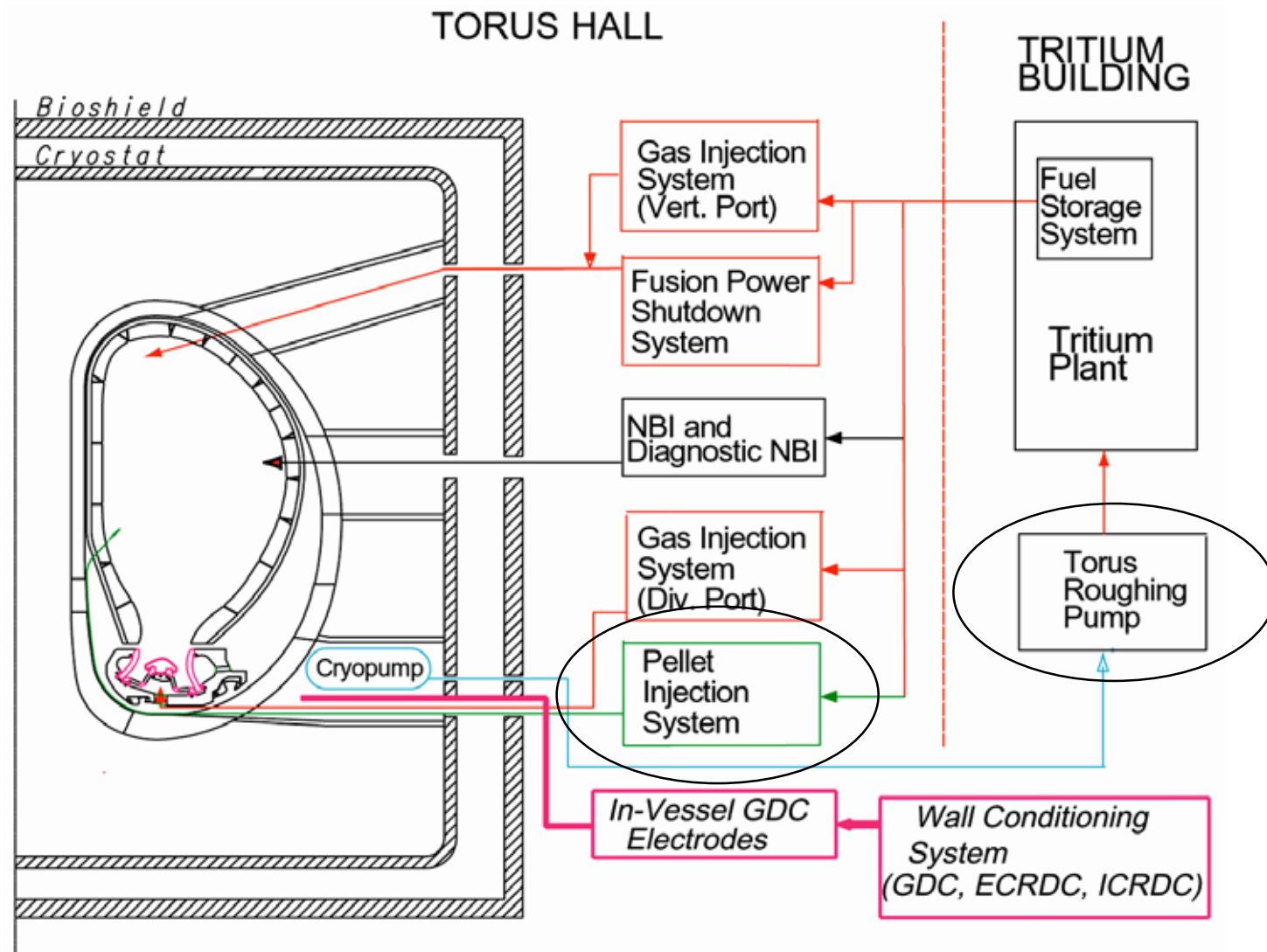

# High Field Side Launch will be Utilized

- Inside wall pellet injection for deep fueling and high efficiency.
- Guide tubes bring the pellets through the divertor ports to the inner wall.
- Similar to guide tubes on ASDEX and DIII-D

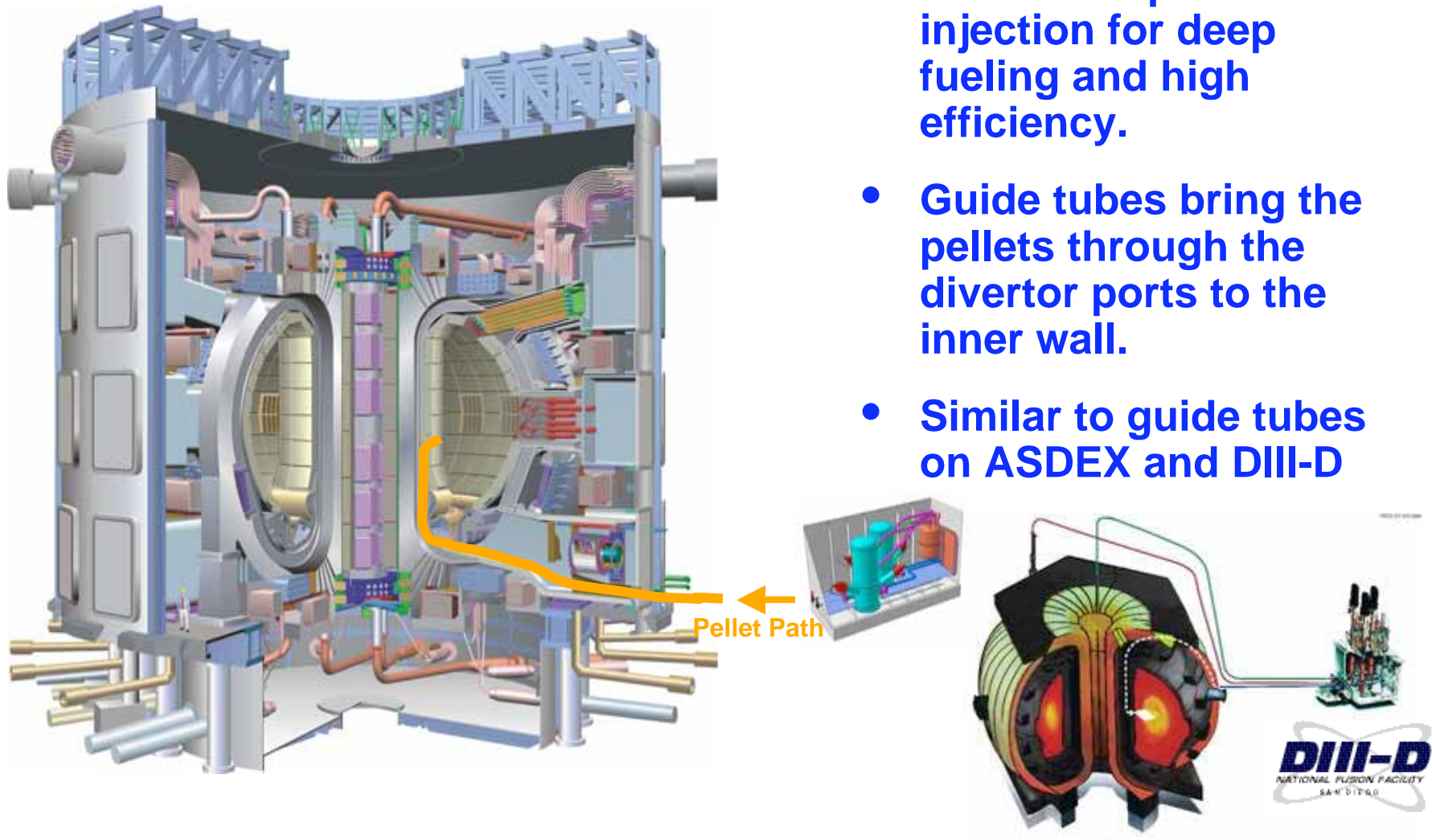

# Pellet Injection and Pumping Activities

- No R&D for the pumping system
- R&D needed for the pellet injector
  - ITER class screw extruder mockup
- Detailed design of pellet injection system

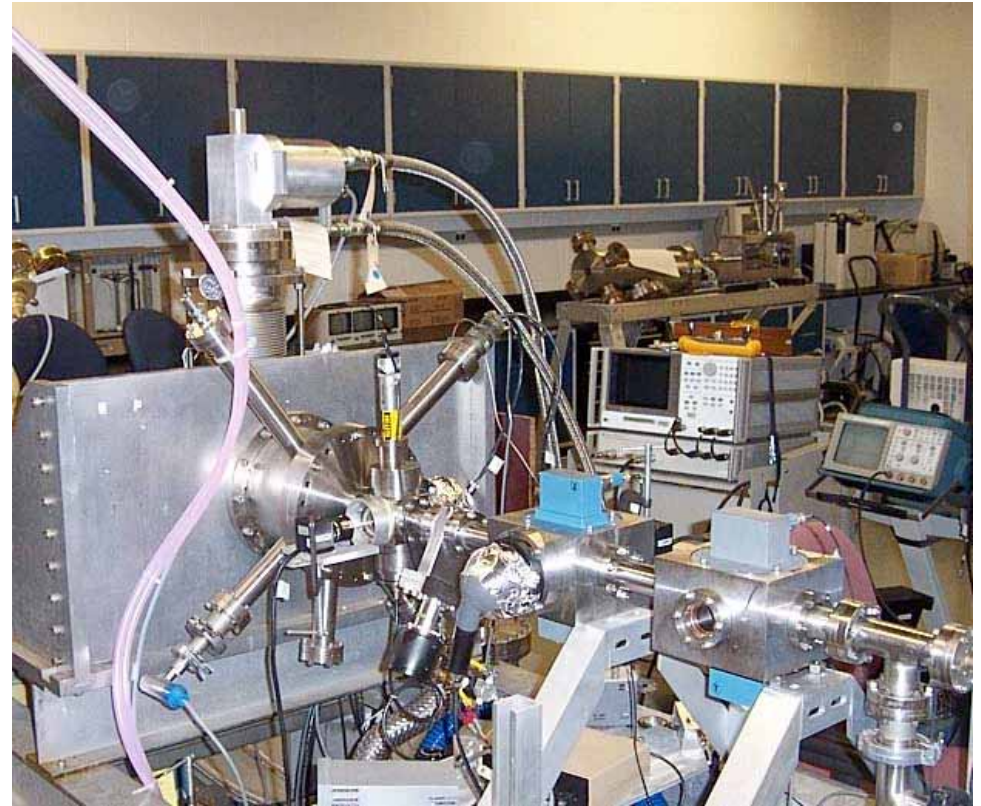

## ITER Fueling Systems Requirements and Pre-conceptual Design

<b>Plasma Density (<math>n_{GW}</math>)</b>	<b>0.4 - 1</b>
<b>Fuel Isotope</b>	<b>Pellet (90%T/10%D)</b>
<b>3-5 mm diam =&gt; <math>1.25-6 \times 10^{21}</math> particles</b>	<b><math>\Delta n/n \sim 1.3\%-6.6\%</math></b>
<b>Gas Fueling Rate (Pa-m<sup>3</sup>/s)</b>	<b>Up to 400 (~3000 torr-L/s)</b>
<b>Pellet Fueling Rate (Pa-m<sup>3</sup>/s)</b>	<b>120 for D<sub>2</sub>, DT (~900 torr-L/s) 70 for T<sub>2</sub> (~525 torr-L/s)</b>
<b>Pulse length (s)</b>	<b>Up to 3000</b>

**Tritium**

**Processing**

# Tritium

- ~ 0.1 gram of Tritium burned each 100 seconds
- ~ 25 grams of Tritium recycled each 100 seconds

# The ITER Tritium Plant is essentially a small chemical processing plant consisting of seven systems

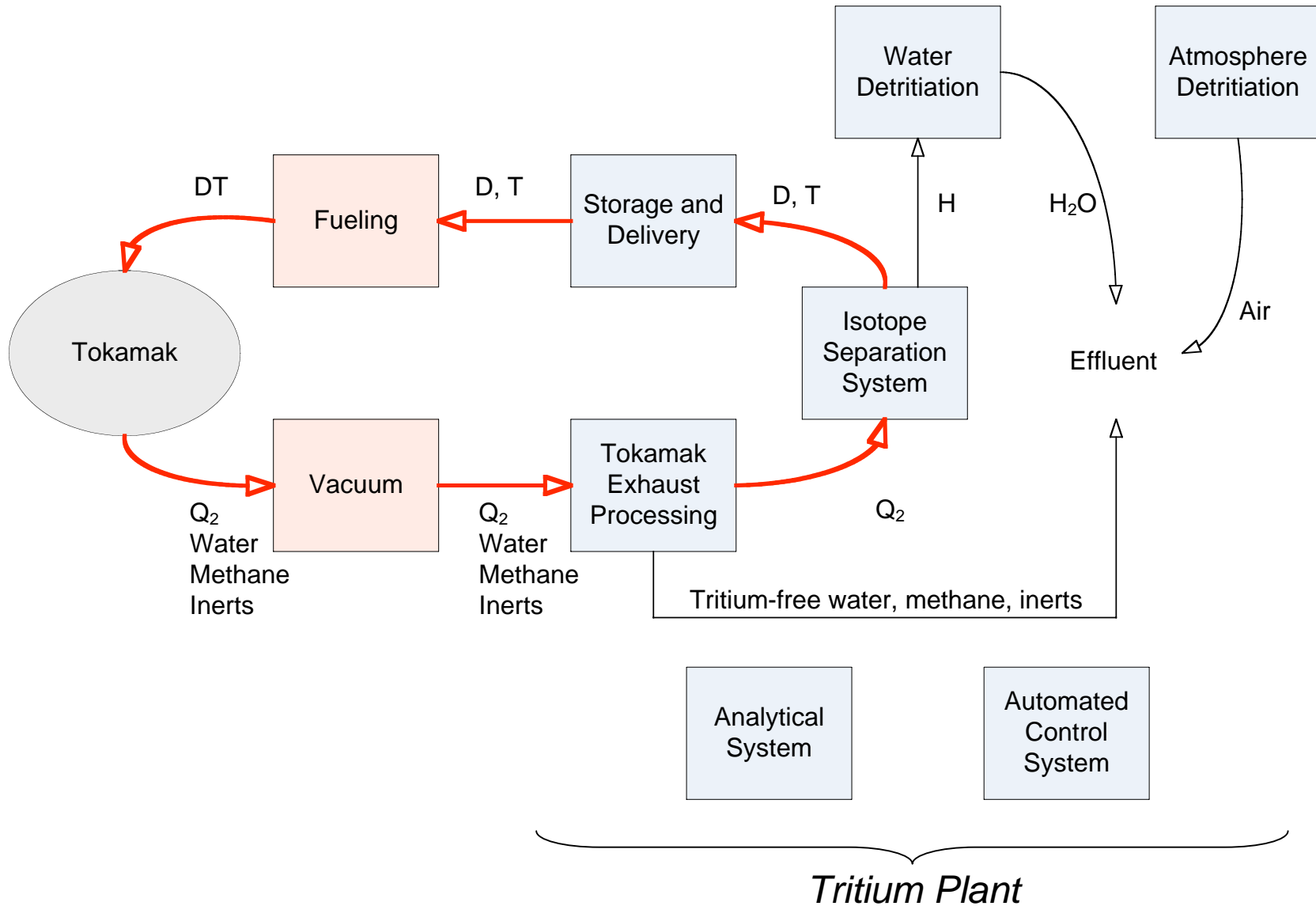

# Overview of ITER Tritium Plant

## FY05-06 activities

- integrated design of the overall ITER Tritium Plant
- detailed design of the Tokamak Exhaust Processing System

- 10x's flowrate
- 10x's inventory (initial ITER charge of tritium ~1000 gm, expensive, and ~5% of available supply)
- 1/10th the processing time

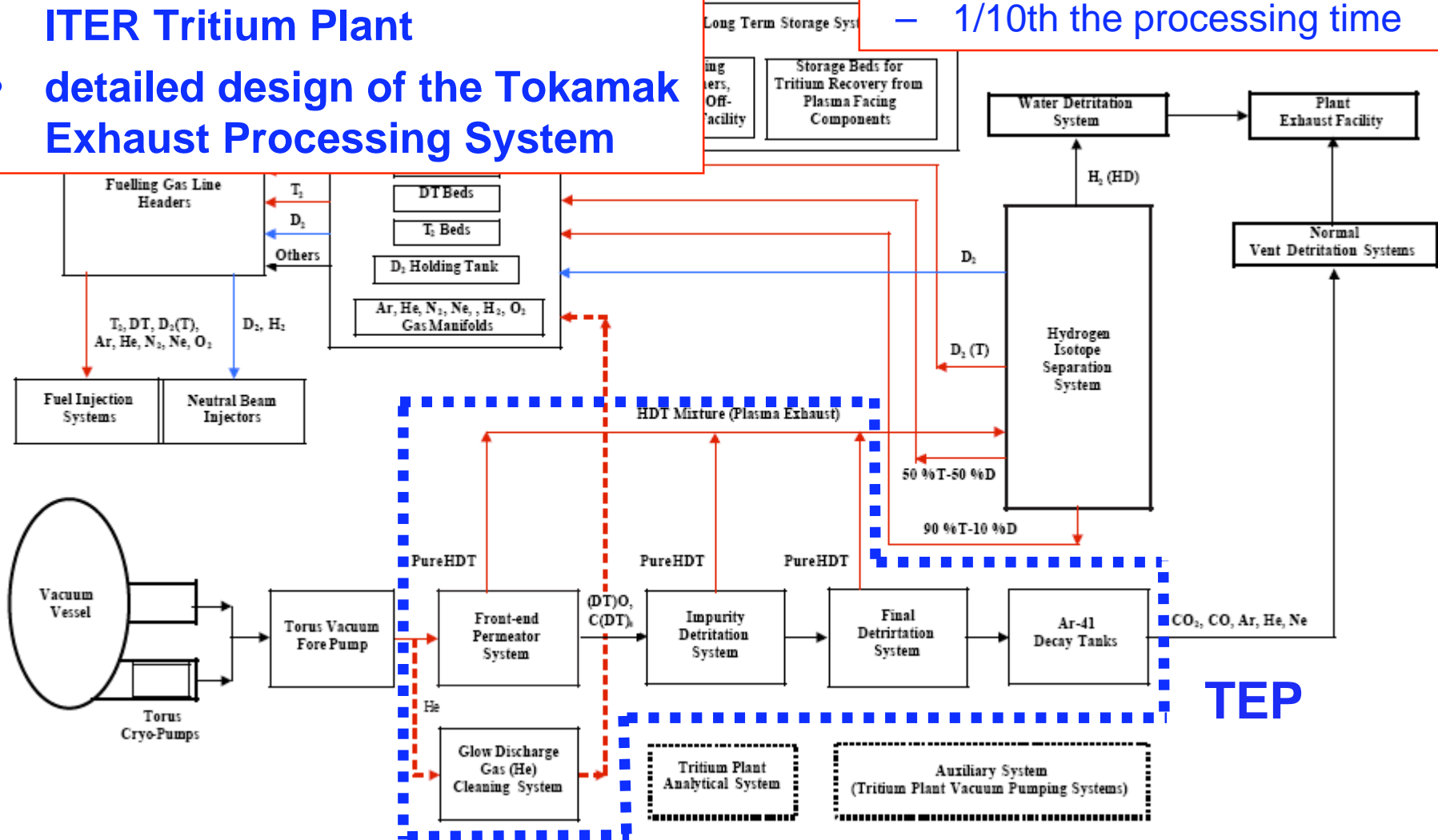



# Major TEP components

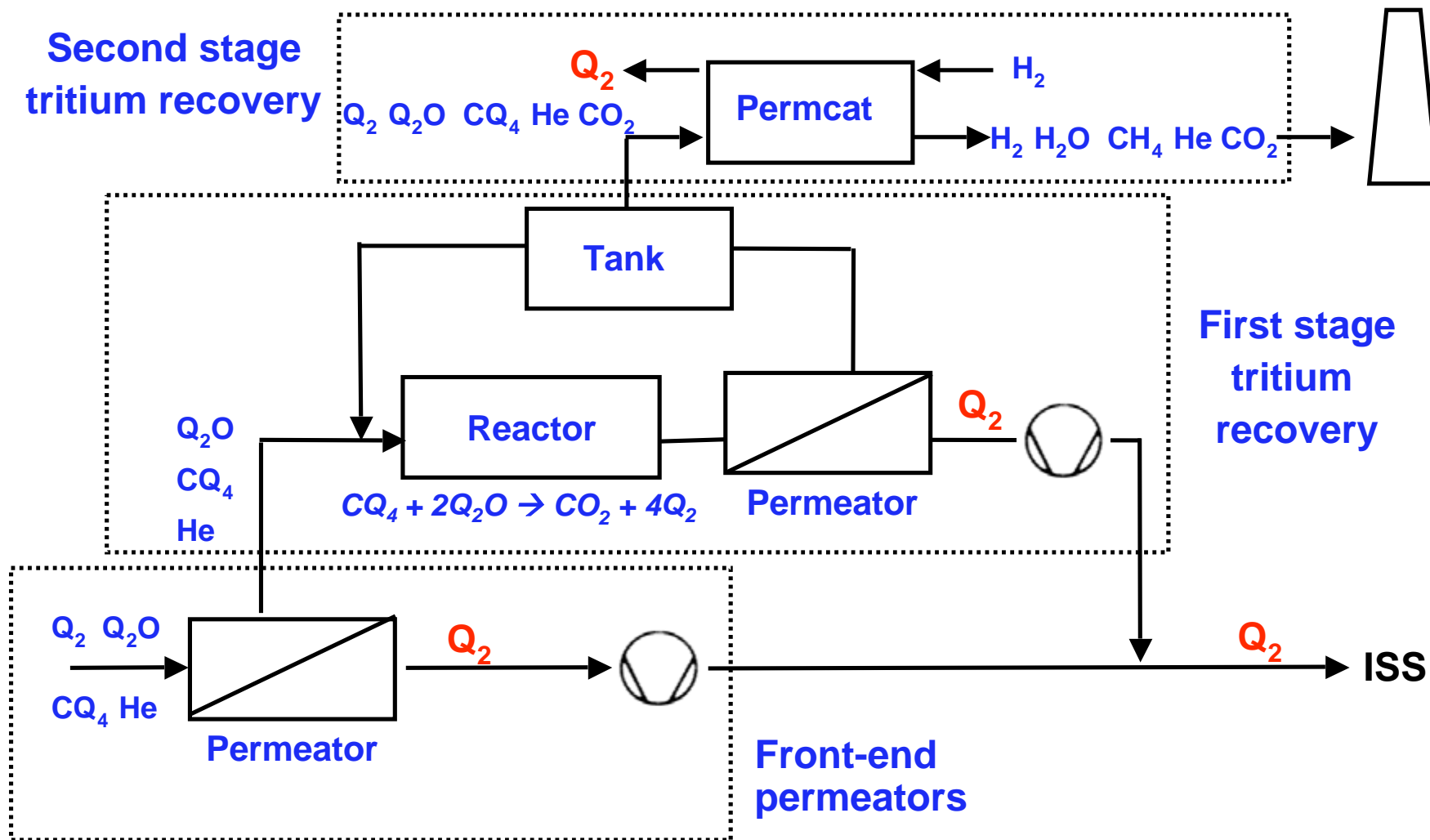

# Diagnositics

# Instrumentation is key to science on ITER

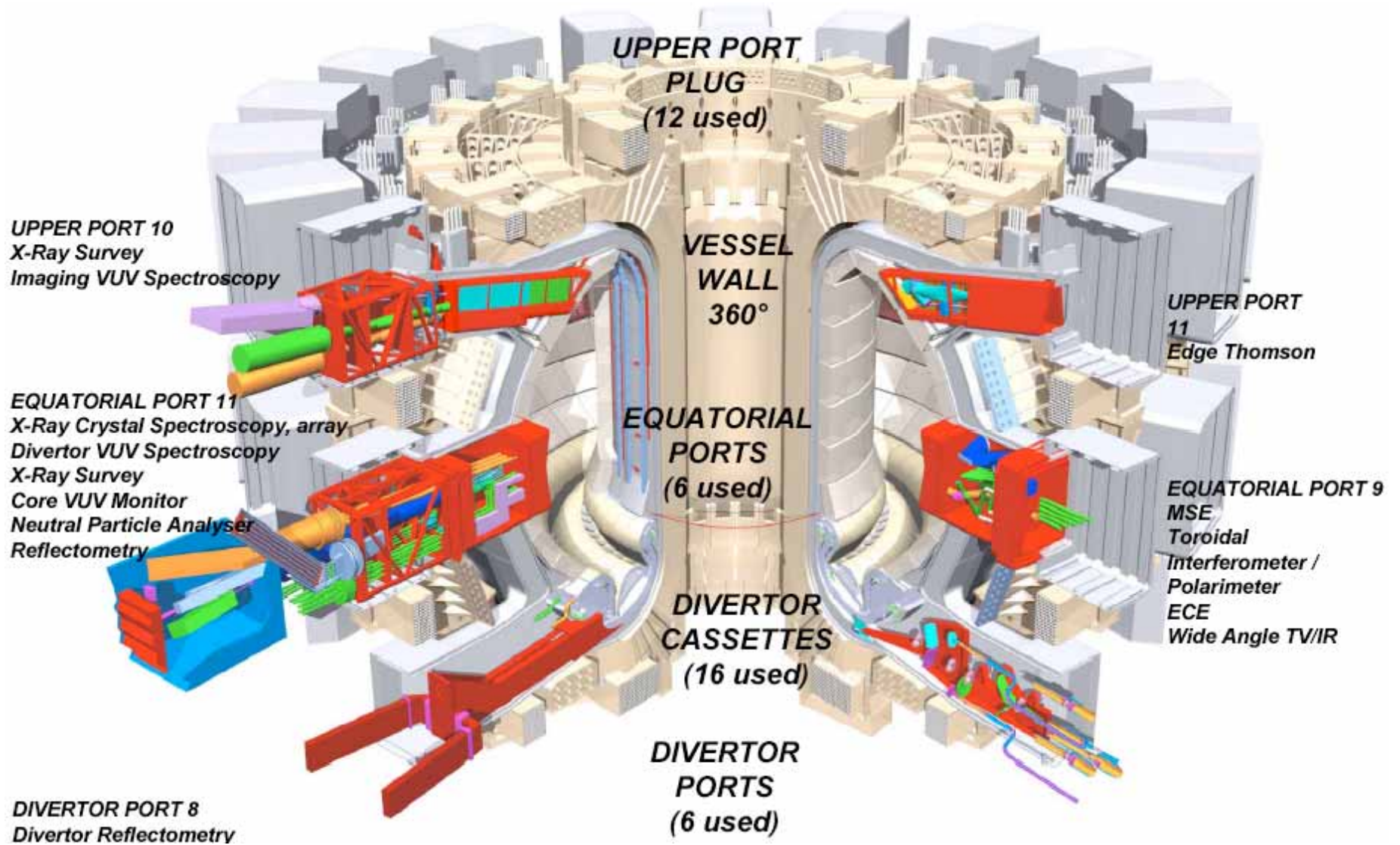

## Example - Motional Stark Effect Diagnostic

- MSE system consists of 'front-end' viewing optics and a fiber optic relay systems to bring signals to detectors in the diagnostic hall.
- Two viewing systems of two heating beams provide good spatial resolution for edge and core regions.
- R&D issues
  - survivability of first mirror and other mirrors, sensitivity of polarization characteristics to deposition
  - polarimetry vs precision spectroscopy
  - in-situ calibration techniques

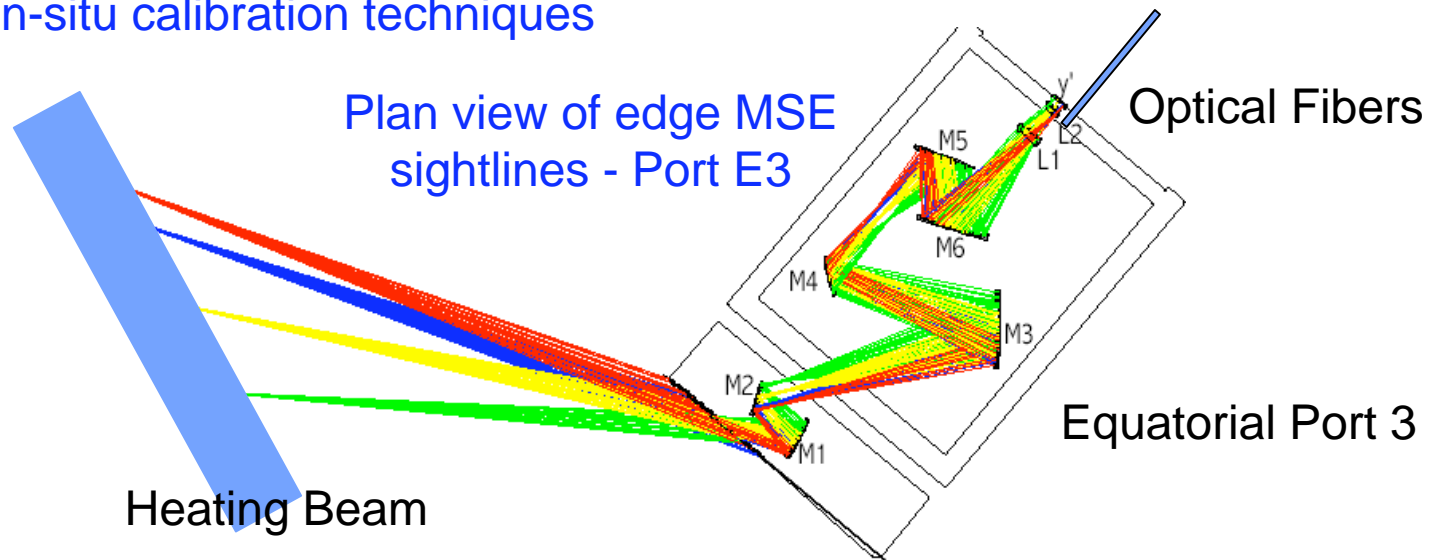

# Diagnostic Port Tasks Involve Significant Integration

- **Design constraints**

- Intermingling of numerous labyrinths, many with precision optics
- Provide access while limiting neutron streaming
- Provide attachments and cooling to blanket shield modules

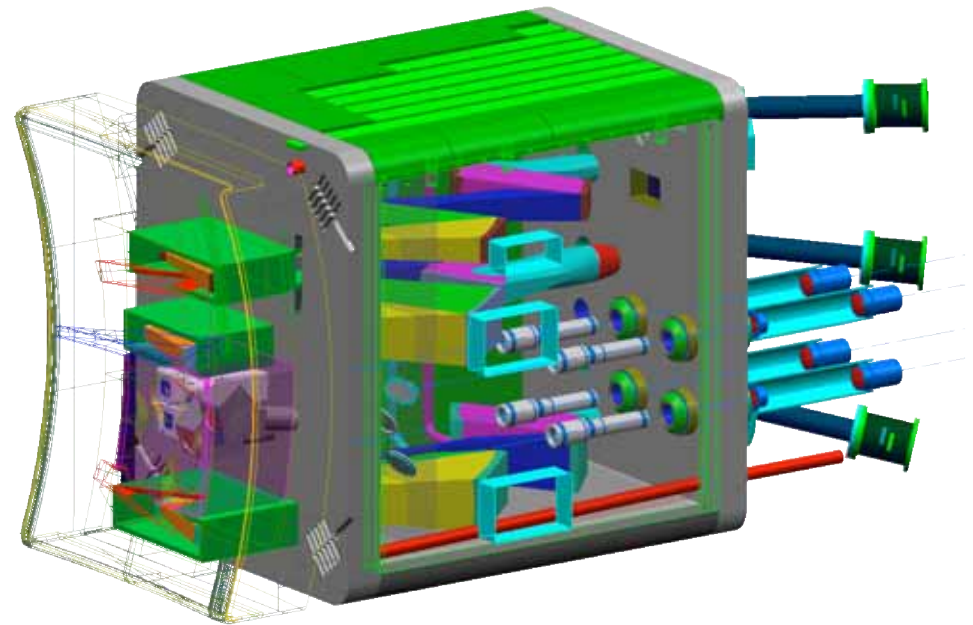

- **Example - Port E3 is a US responsibility**

- US will provide the MSE system as the 'lead diagnostic'
  - Edge MSE view in port E3 (US) and core view in port E1 (EU)
- US is also responsible for integrating the following into port E3
  - Visible/IR camera view (EU)
  - Two edge CXRS views (RF)
  - $H_{\alpha}$  arrays (RF)

**Manage-  
ment**

# Management Structure considered during international discussions of the Negotiator's Standing Sub-Group

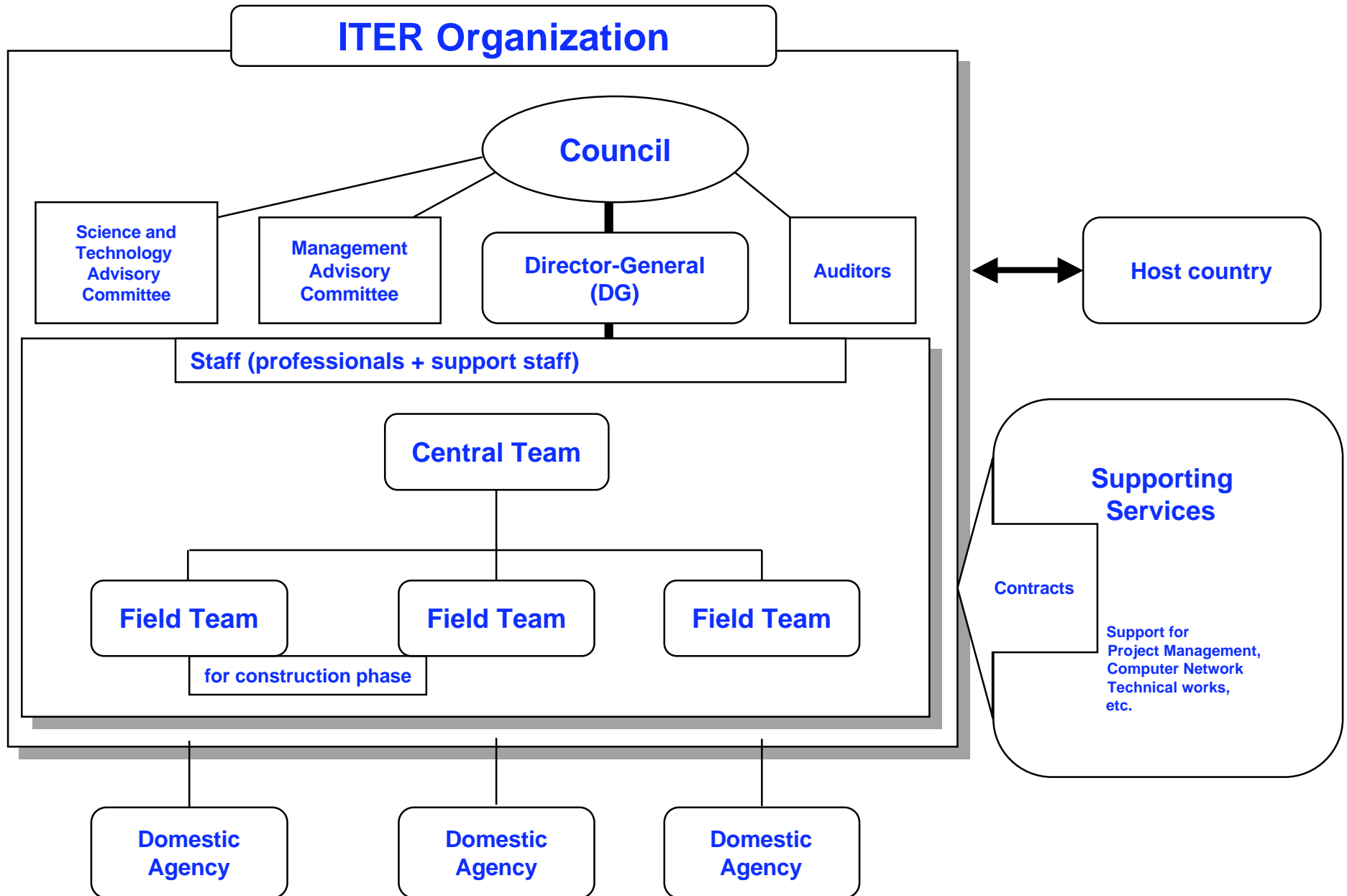

**Barabaschi: Roles and Responsibilities:  
The Parties cannot be simultaneously stakeholders and suppliers.**

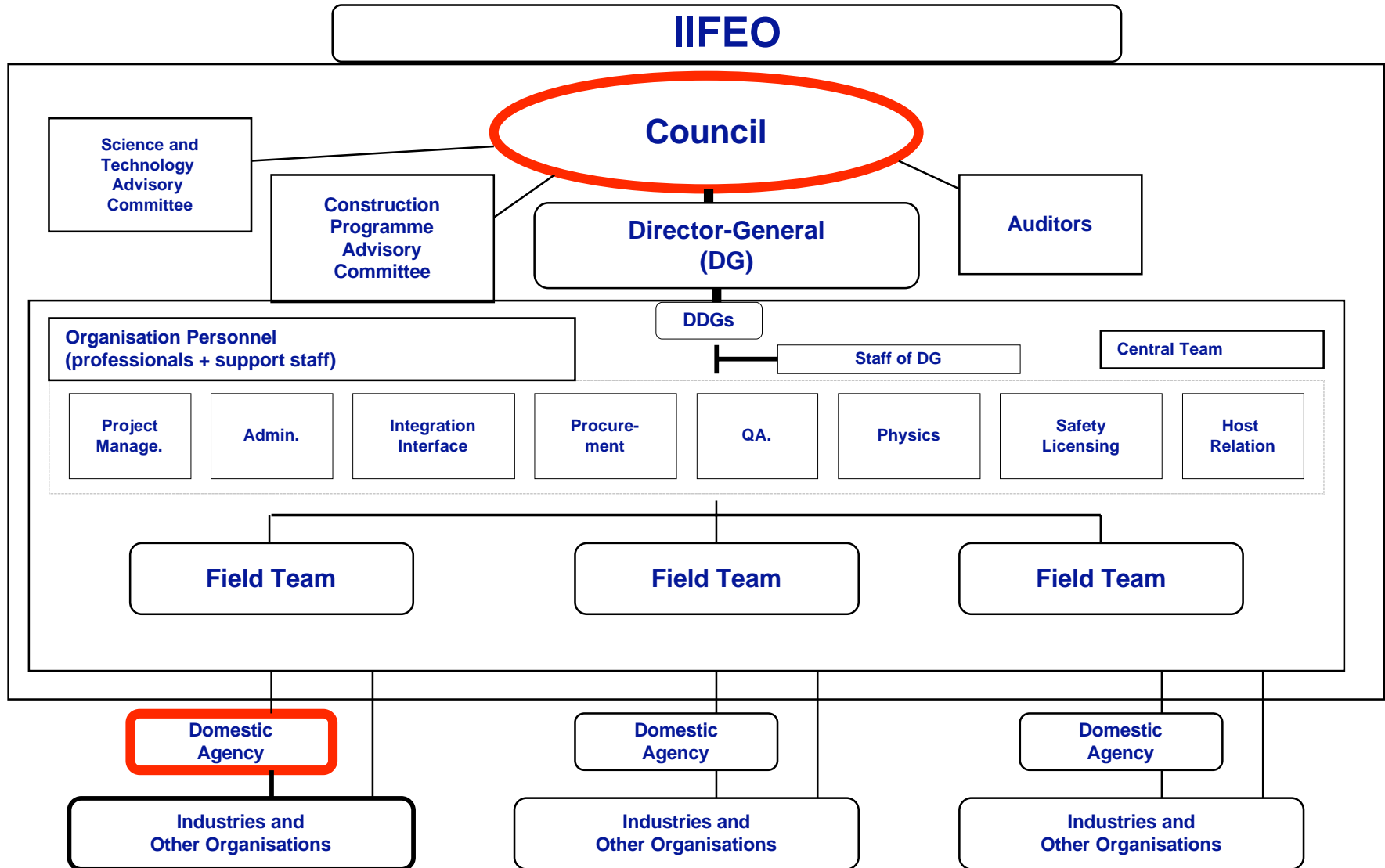



## **Following the site-decision, innovative arrangements will be needed**

- **Procurement systems, including in-kind contributions and change management**
- **Resource management, with most funds remaining in the parties**
- **Staffing by secondees, direct employees of the international organization, and contracts**
- **Engaging the world's industrial base for roles in management, fabrication, assembly/installation, and operations**
- **Engaging the worldwide fusion research community to see ITER as an opportunity**
- **Effective distributed project management that integrates the activities of the parties**

# Next Steps

---

---

- **Select ITER site and Director General**
- **ITER Negotiators from the six parties initial the international ITER Agreement**
- **U.S. must obtain a mandate from the Department of State to authorize the U.S. to sign the ITER Agreement**
- **All Parties sign (and ratify) the Agreement and establish ITER Legal Entity**
- **Form the ITER staff at the selected site, including assignment of U.S. personnel.**
- **Continue project activities in U.S., including the critical decision milestones.**

# Management Structure for the US ITER Project and Program

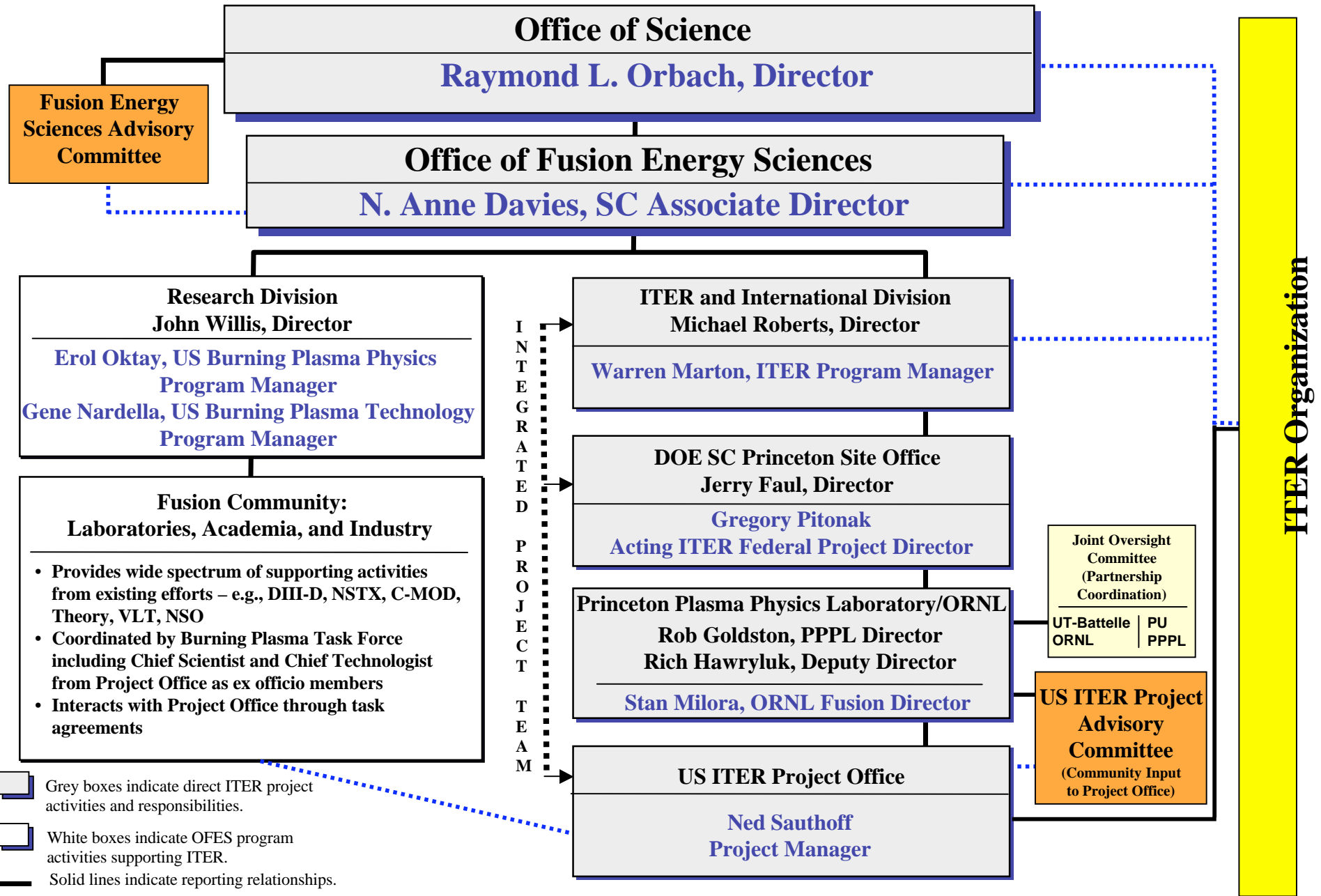

- Grey boxes indicate direct ITER project activities and responsibilities.
- White boxes indicate OFES program activities supporting ITER.
- Solid lines indicate reporting relationships.
- Dashed lines indicate coordinating relationships.

Note: This chart does not display the necessary organizational relationships with the legal, financial, and construction management offices within DOE.

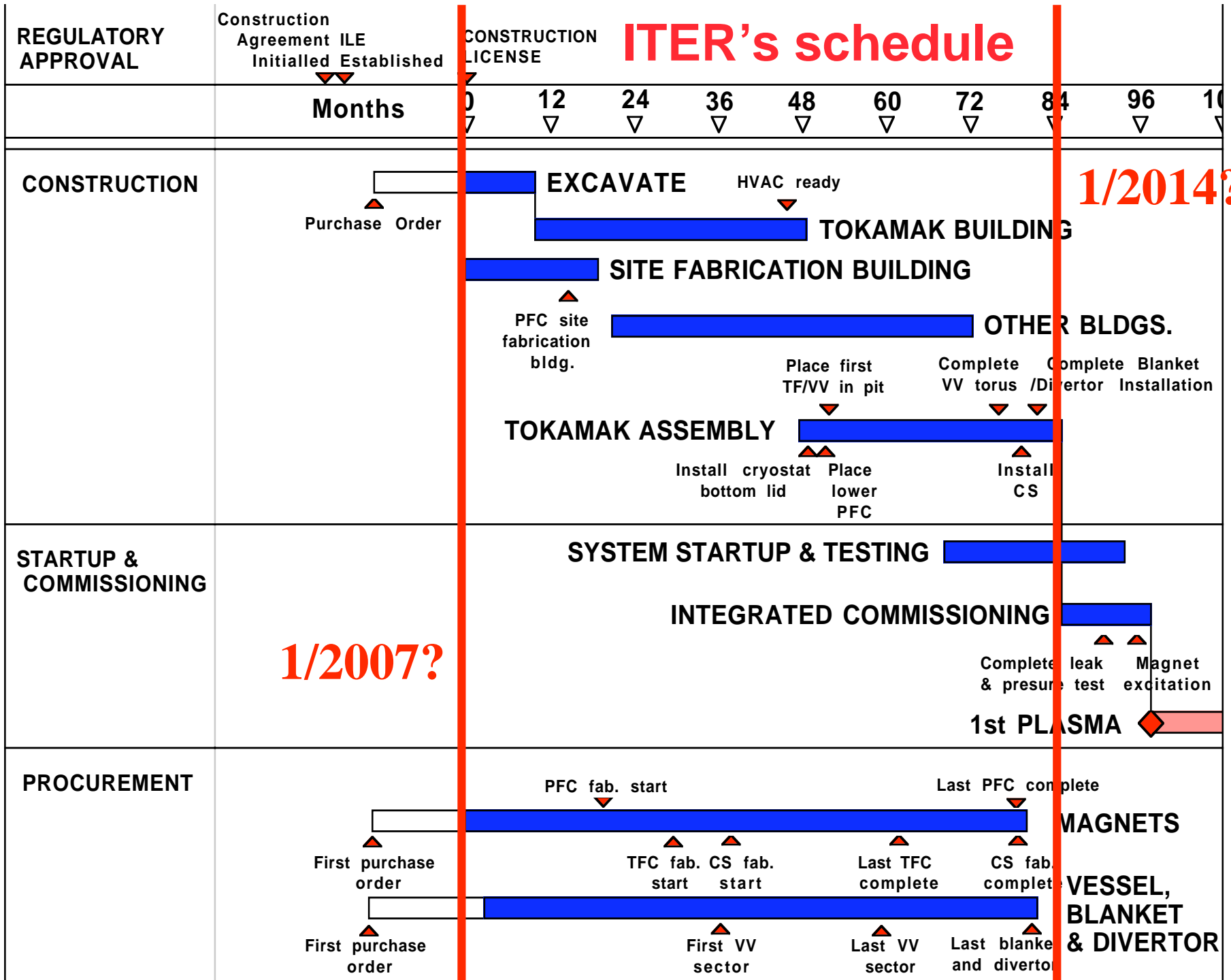

## Cost Baseline Range

Minimum TPC	Feb 2005 Estimated TPC	Maximum TPC
\$1115M	\$1184M 22.9% contingency*	\$1291M 30% contingency*

\*Percentage based on all scope other than  
“Support to the International Team” (\$189M), which has  
no contingency in the Estimated TPC because of  
the scope being specific cash and staff-years

# FY2006 President's Budget Request

## Funding Profile for ITER

### U.S. Contributions to ITER - Annual Profile

(dollars in thousands – in as spent dollars)

Fiscal Year	Total Estimated Costs (TEC)	Other Project Costs (OPC)	Total Project Costs (TPC)
2006	46,000	3,500	49,500*
2007	130,000	16,000	146,000
2008	182,000	18,800	200,800
2009	191,000	16,500	207,500
2010	189,000	10,300	199,300
2011	151,000	9,300	160,300
2012	120,000	6,200	126,200
2013	29,000	3,400	32,400
<b>Total</b>	<b>1,038,000</b>	<b>84,000</b>	<b>1,122,000</b>

\* Discussions are under way about whether ITER Preparations funding in FY06 of \$6M should be accounted for within the ITER Total Project Cost (TPC).

## Scientific and technological work continues

- **Despite the lack of site-decision, technical work continues**
  - completing R&D and design on in-kind contributions
  - Manufacturing studies and vendor qualification
- **The International Tokamak Physics Activity is identifying and addressing key scientific questions that relate to the performance of burning plasmas**
  - Supporting the design activity
  - Leading to more effective research on ITER by
    - Improving understanding
    - Discovering new integrated scenarios to exploit understanding
    - Building integrated tools and simulations
    - Developing a strong work-force
    - Integrating international topical teams as precursors for ITER's research operations

## The Bottom Line....

- **Scientific and technological assessments have affirmed**
  - the significance of burning plasma science
  - the readiness of the tokamak as a vehicle for the study of toroidal magnetically-confined self-heated plasmas.
  - the scientific and technological benefits and readiness of ITER
- **The world fusion community is striving to start the construction of ITER to enable burning plasma research.**
- **ITER should serve as a major facility for the study of reactor-scale long-pulse toroidal plasmas, providing burning plasma research opportunities in the 2015-2035 period.**

